

Quick Start Guide



SILENT ANGEL

Munich

M1 / M1T

Digital Music Player

HiFi-Grade Network Streamer, Enjoy the Ultimate Sound Quality



Table of Contents

Package Contents	01
Front Panel	01
Rear Panel	02
Make Connections	04
Scenarios	04
Power Connection	06
Power On	06
Install the Mobile App	06
Use Mobile Device to Control M1 / M1T	07
Device Search Guide	08

Package Contents



M1 / M1T x1

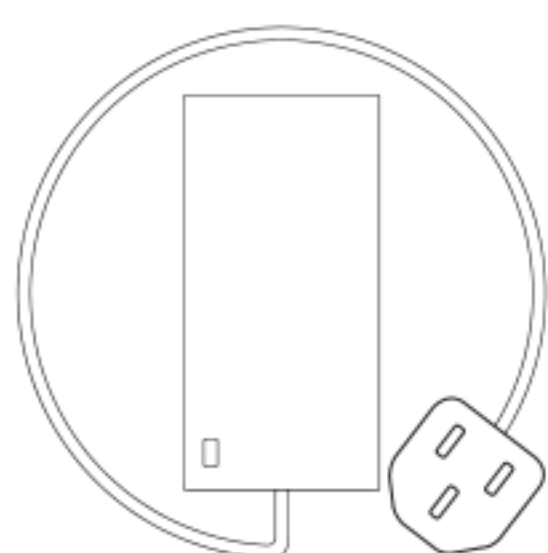

Power Adapter x1

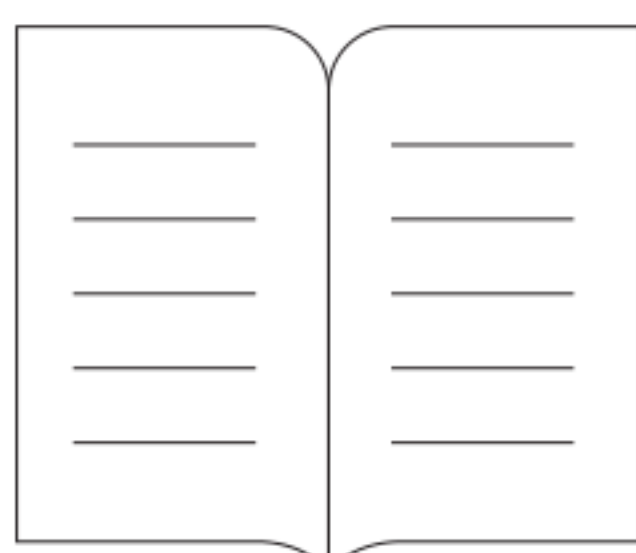

Product User Manual x1

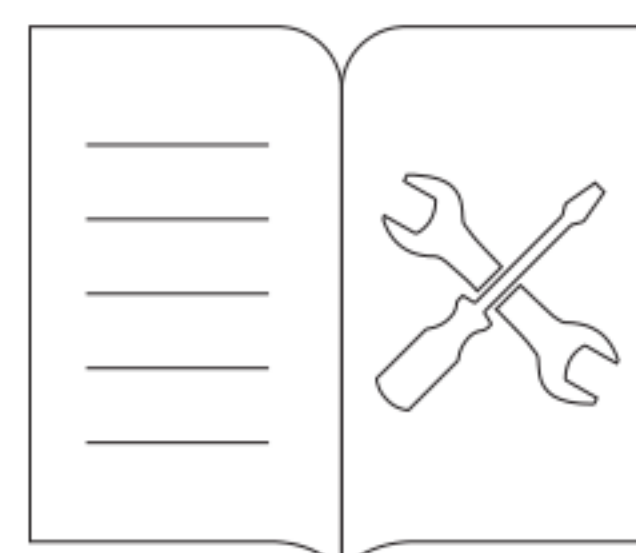

Warranty Card x1

Front Panel

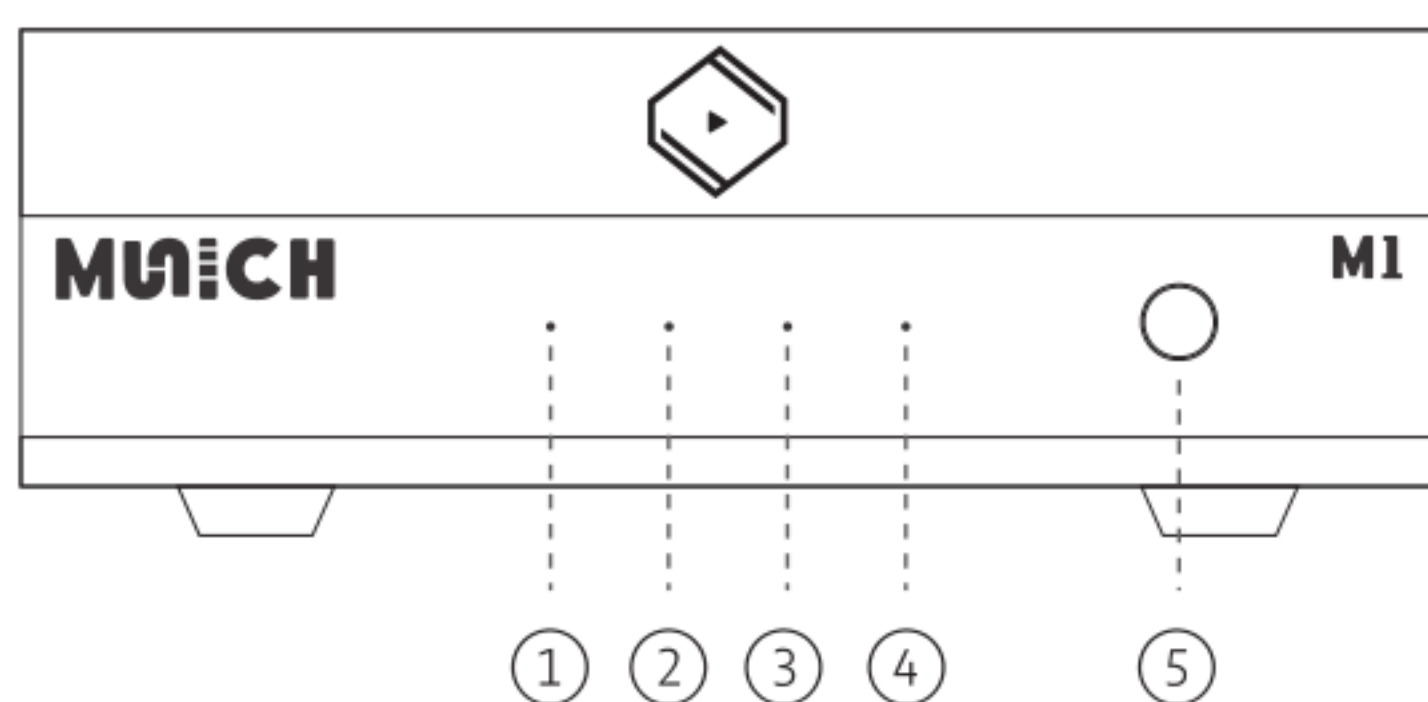

M1

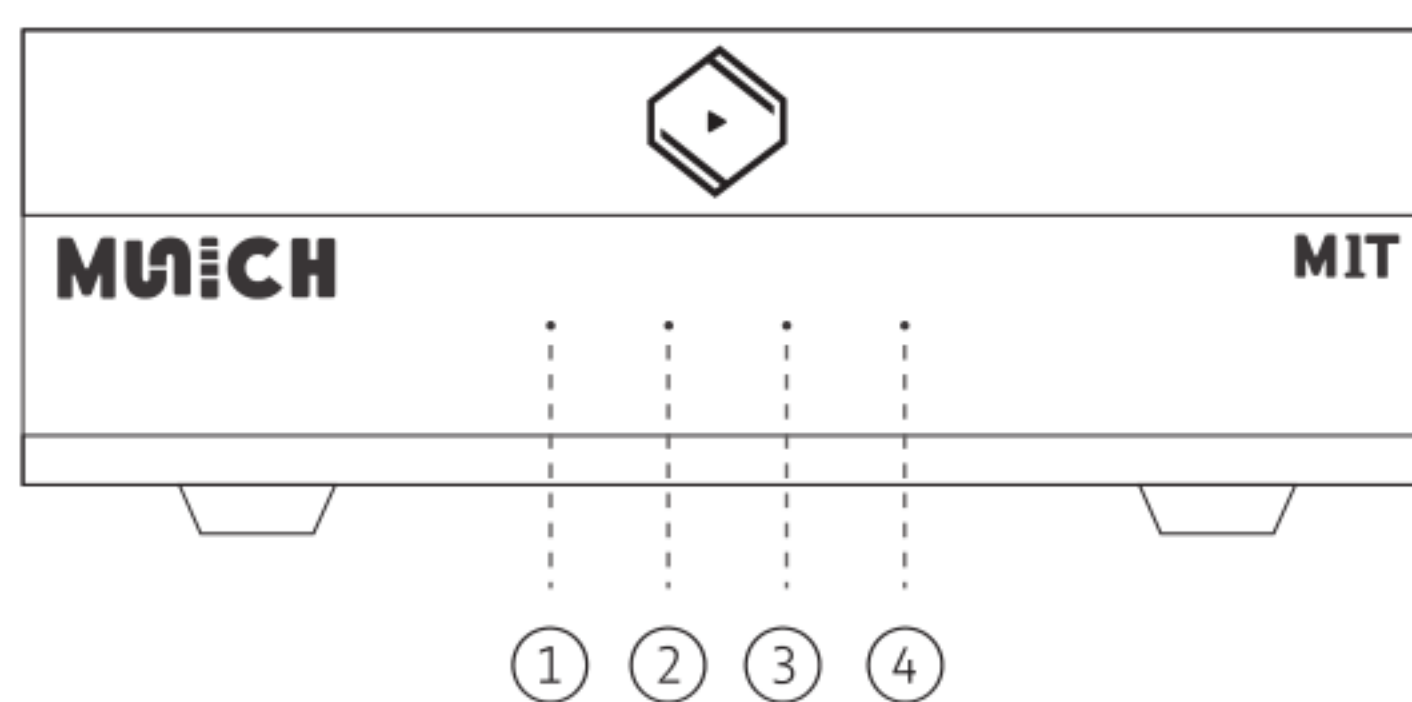

M1T

① Mute status indicator

When the volume is reduced to 0, the red light flashes slowly

② Power Status Indicator

The green light is on when the power switch is turned on and the power input is good
When the power switch is off or there is no power output, there is no indicator light

③ Start and output status indicators

When the device is booting, the yellow light flashes slowly

When the output format is DSD, the yellow light is on

④ Output status indicator light

Green light is on when the output format is PCM

⑤ 6.35 mm phone jack (only for M1 devices)

Analog audio output for 6.35mm phone jack

Rear Panel

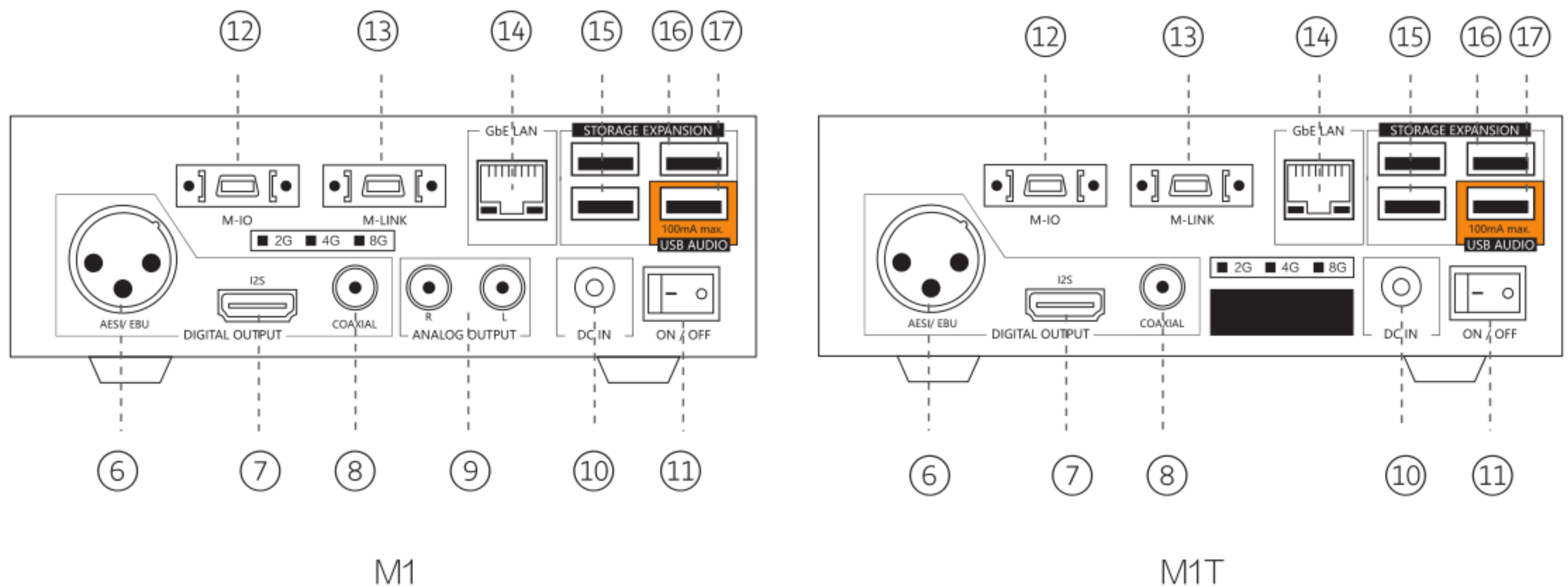

⑥ The AES / EBU interface

Digital audio output, transmitting the S/PDIF digital audio format via a 110 Ohm balance cable.

Description of the three pins in the interface:

Pin 1: ground ground (G)

Pin 2: positive pole (+)

Pin 3: negative (-)

⑦ I2S interface

Digital audio output, support local differential I2S digital audio signal with HDMI cable in LVDS signal standard.

The pin description in the interface is shown in the following figure: Pin

Definitions of the I2S digital audio output

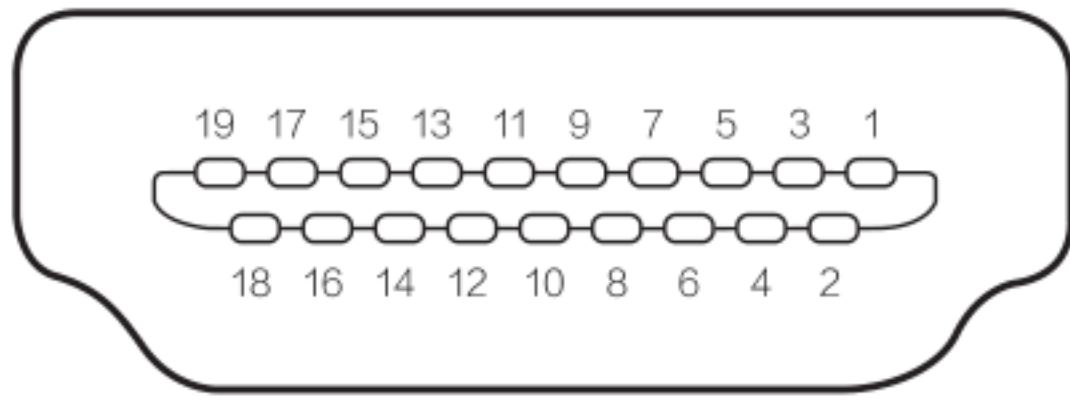

- PIN1 : SDATA - / DSD R -
- PIN2 : GND
- PIN3 : SDATA + / DSD R +
- PIN4 : BCK + / DSD CLK +
- PIN5 : GND
- PIN6 : BCK - / DSD CLK -
- PIN7 : LRCK - / DSD L -
- PIN8 : GND
- PIN9 : LRCK + / DSD L +
- PIN10 : NC
- PIN11 : GND
- PIN12 : NC
- PIN13 : NC
- PIN14 : NC
- PIN15 : NC
- PIN16 : NC
- PIN17 : GND
- PIN18 : NC
- PIN19 : NC

⑧ COAXIAL

Digital audio output, transmitting the S / PDIF digital audio signal via a 75 Ohm coaxial cable

⑨ RCA (L+R) (only for M1 devices)

Analog audio output, amplitude 2Vrms

⑩ DC power input

The 5V DC power supply input port

⑪ Power Switch

Power switch that controls the power on / off

⑫ M-IO

Extended interface for additional peripherals

⑬ M-LINK

Extended interface for additional peripherals

⑭ LAN

The Gigabit Ethernet network port

Amber LED: flashes when connecting to the 100Mbps Ethernet and flashes when the signal is sent or received

Green LED: flashes when connecting the 1000Mbps Ethernet and flashes when the signal is sent or received

⑮ USB 3.0:

USB 3.0 storage expansion port x2

⑯ USB 2.0:

USB 2.0 storage expansion port

⑰ USB audio output:

Connect to a decoder or audio device that supports USB digital audio input

Make Connections



Make sure all audio devices are powered off.

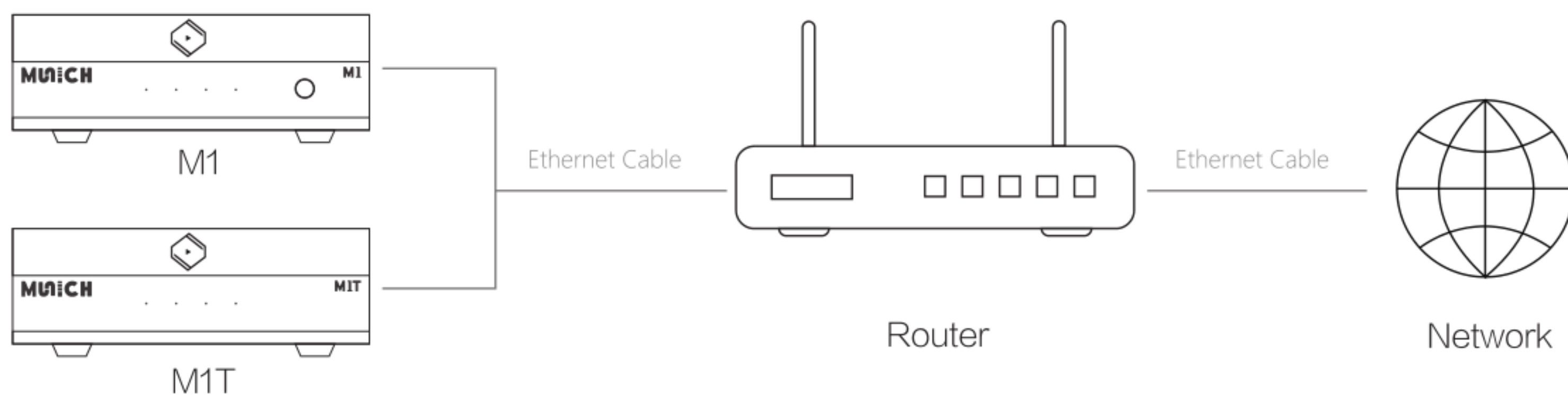

Scenarios

For M1 Only

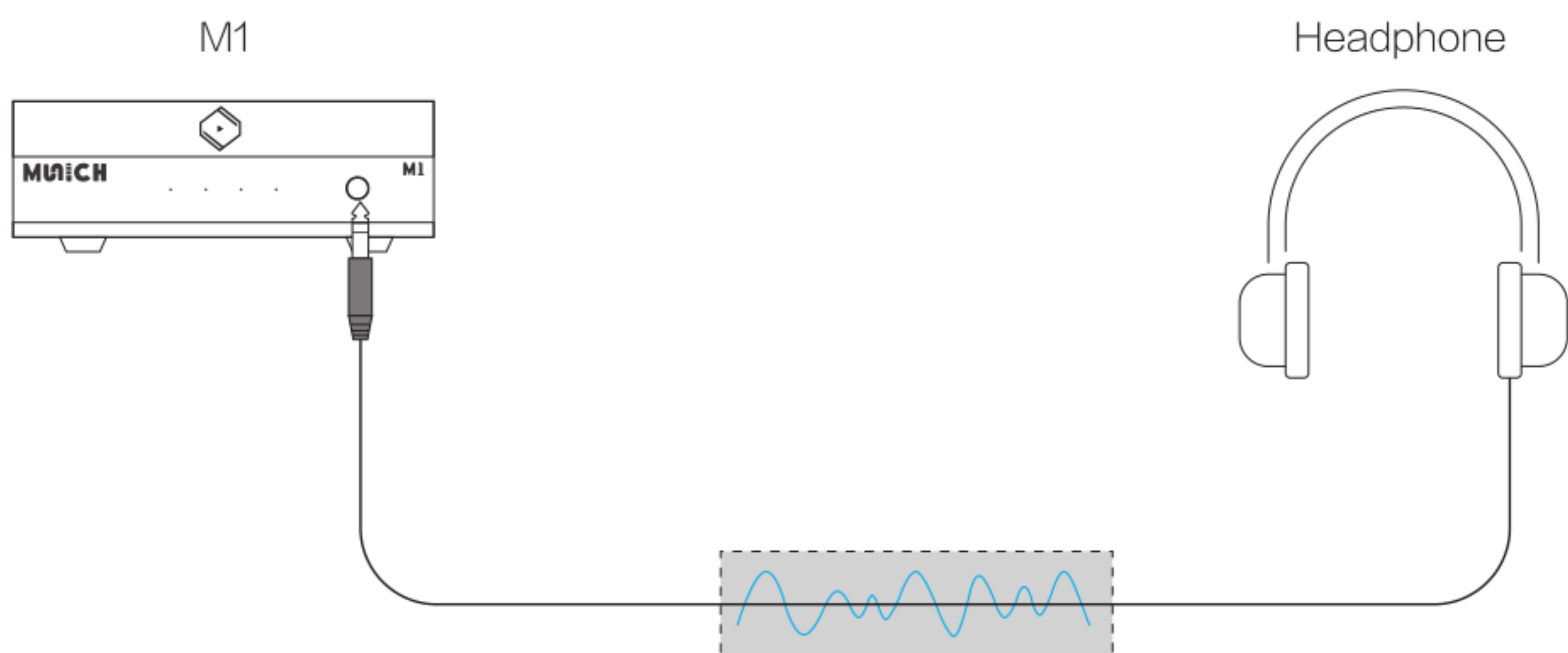

For M1 Only

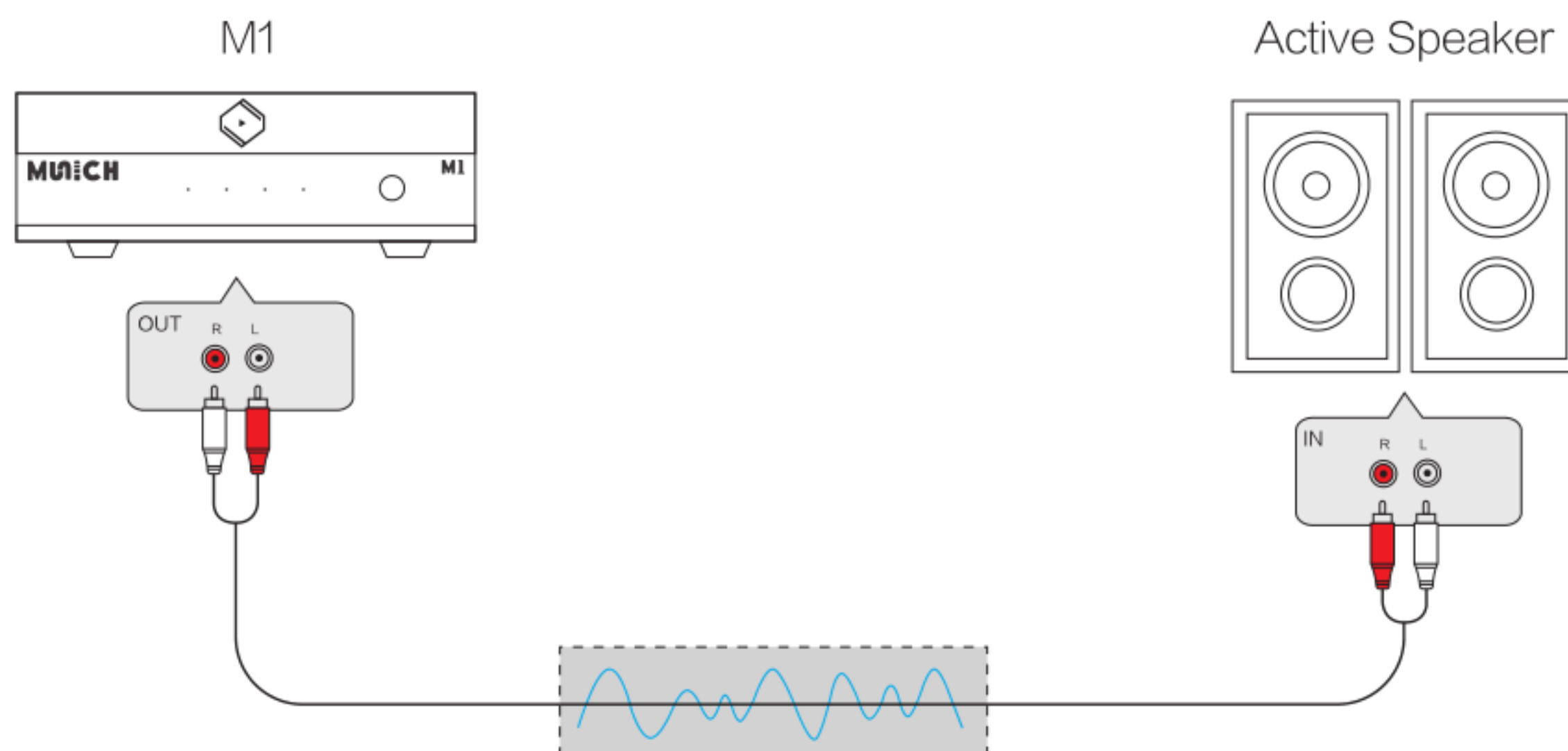

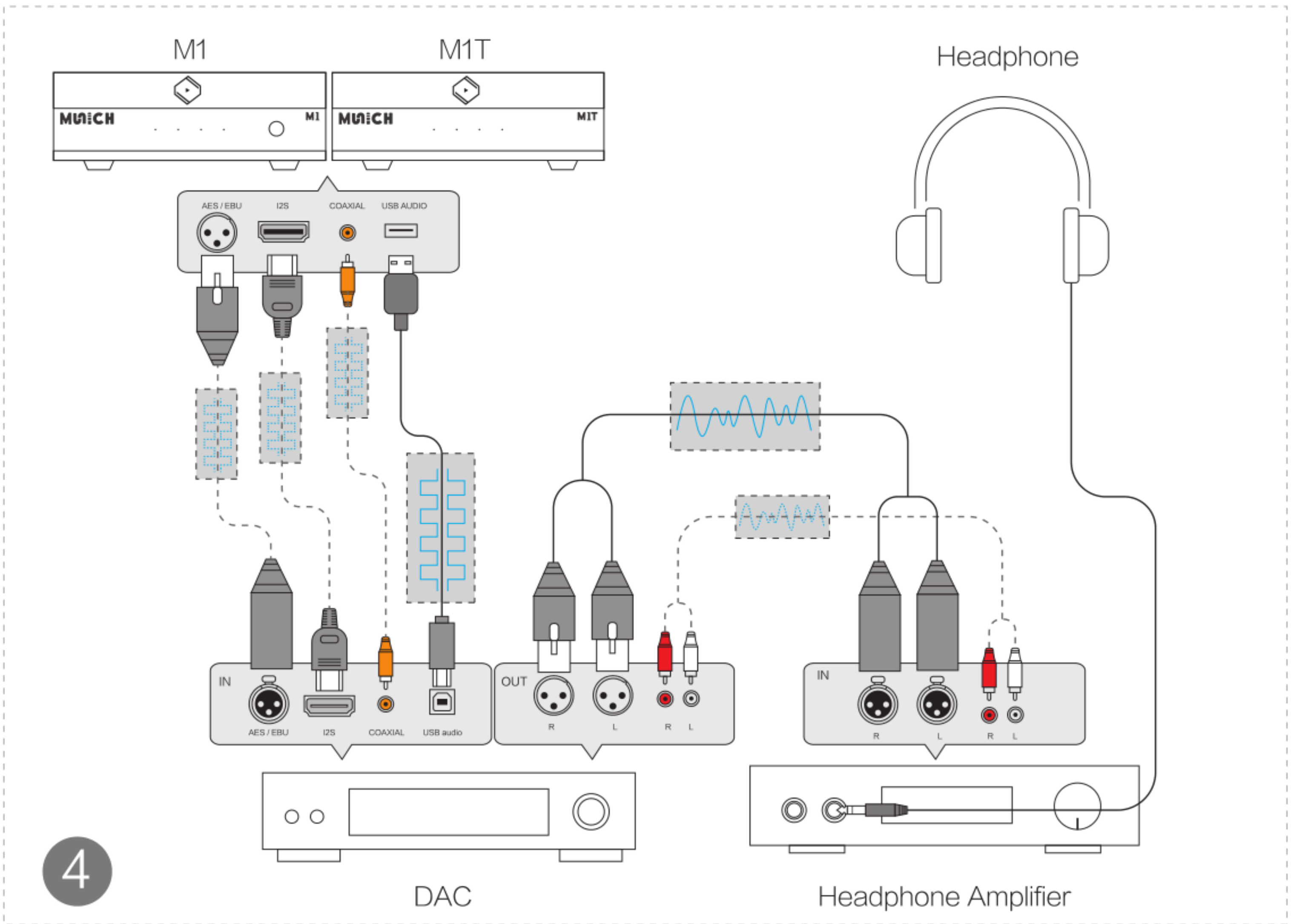
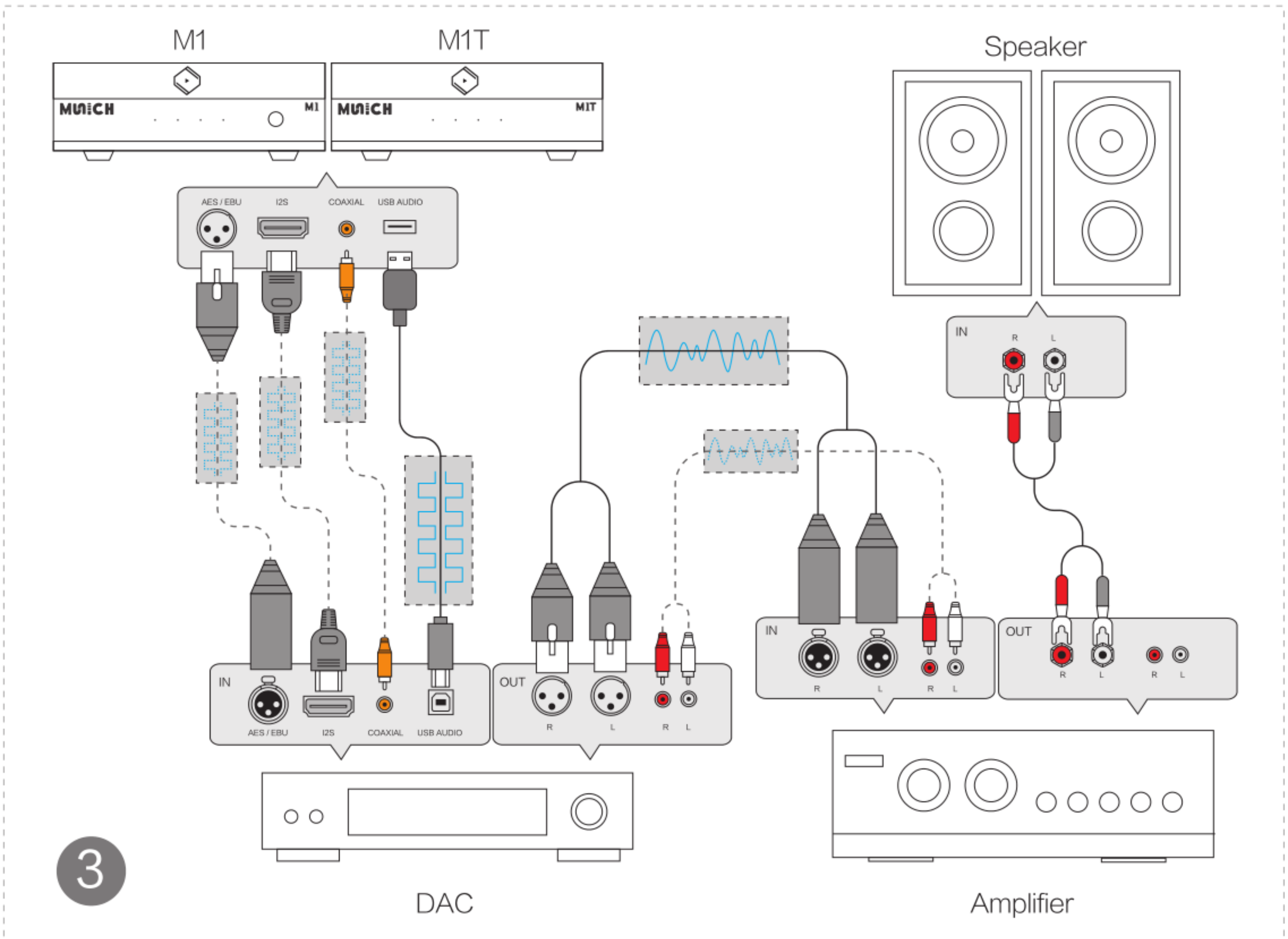

Power Connections

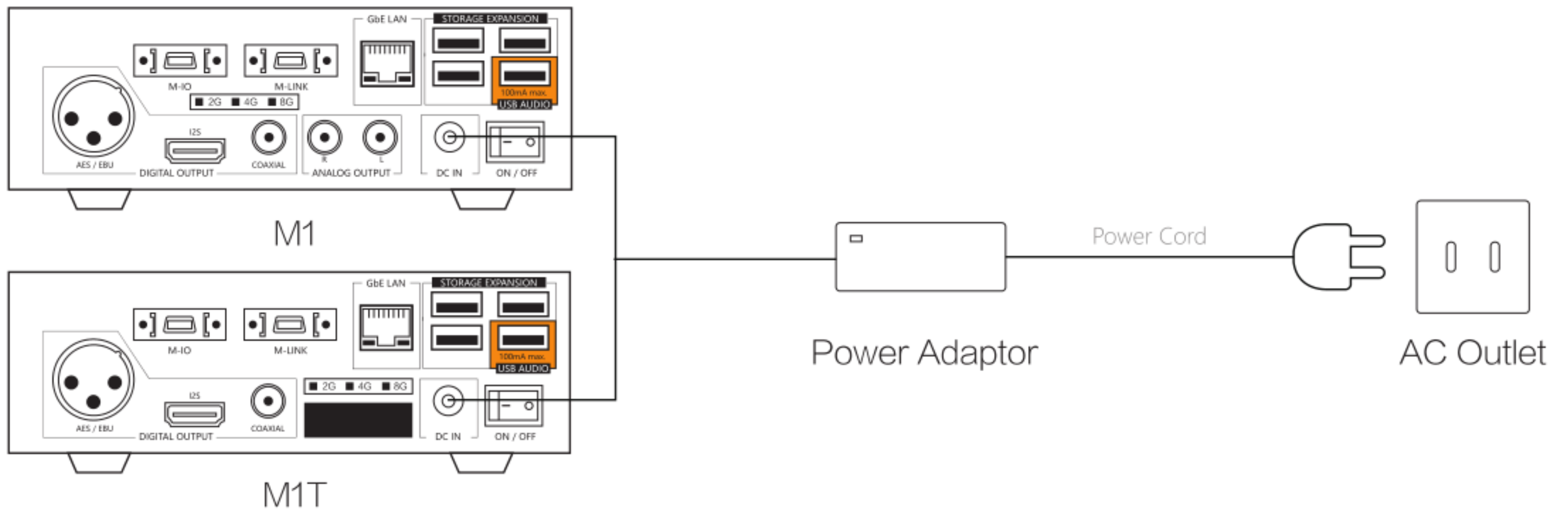

Power On

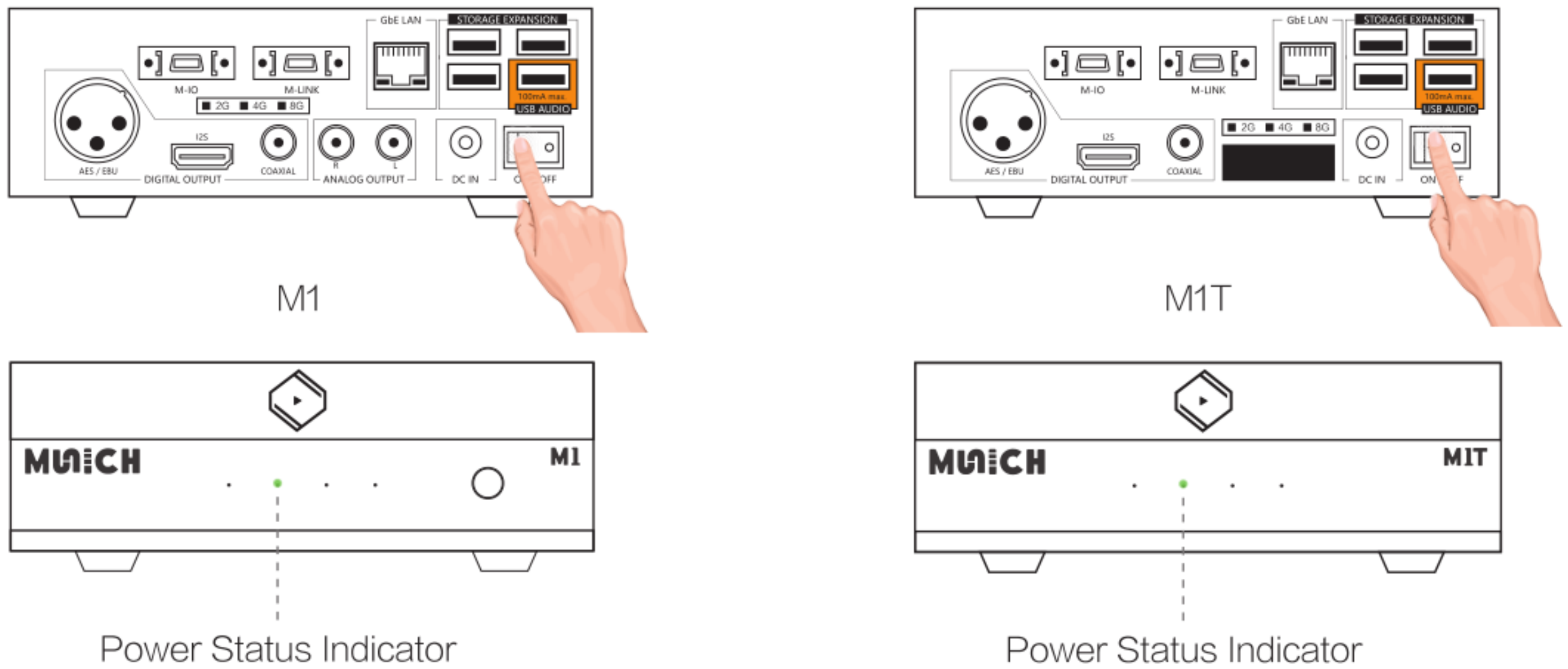

Install "VitOS Orbiter" App on a Pad or Phone

Use below QR code to install "VitOS Orbiter" app on a pad or phone

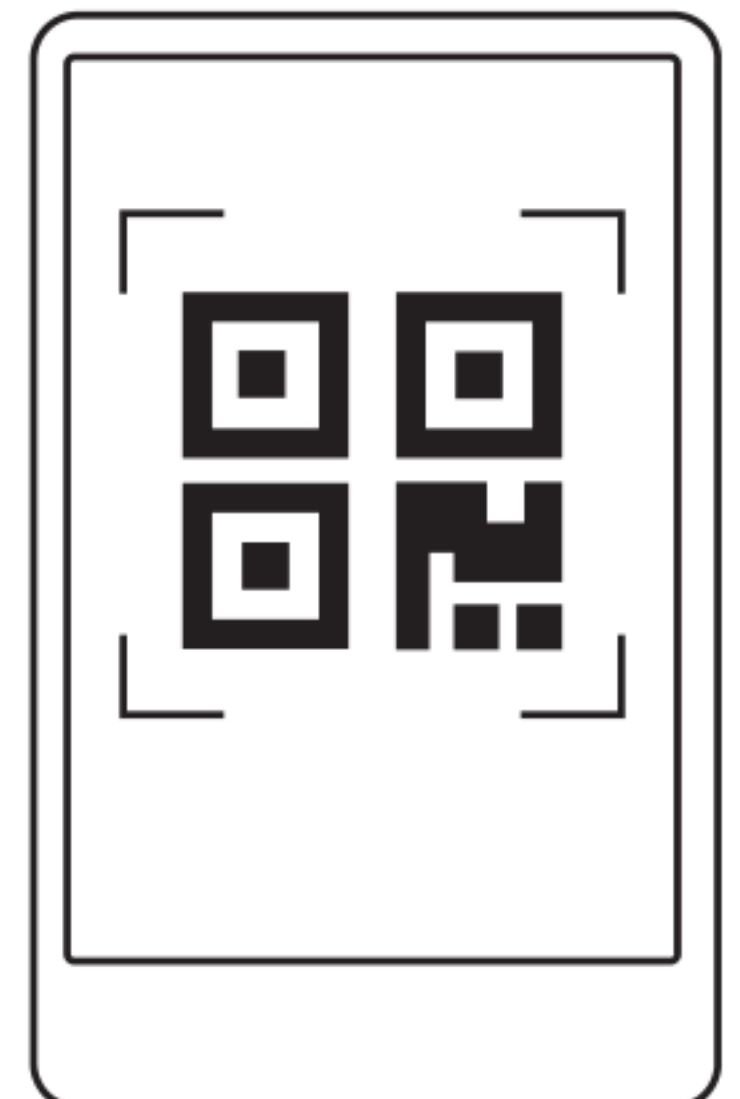

Use Mobile Device to Control M1 / M1T

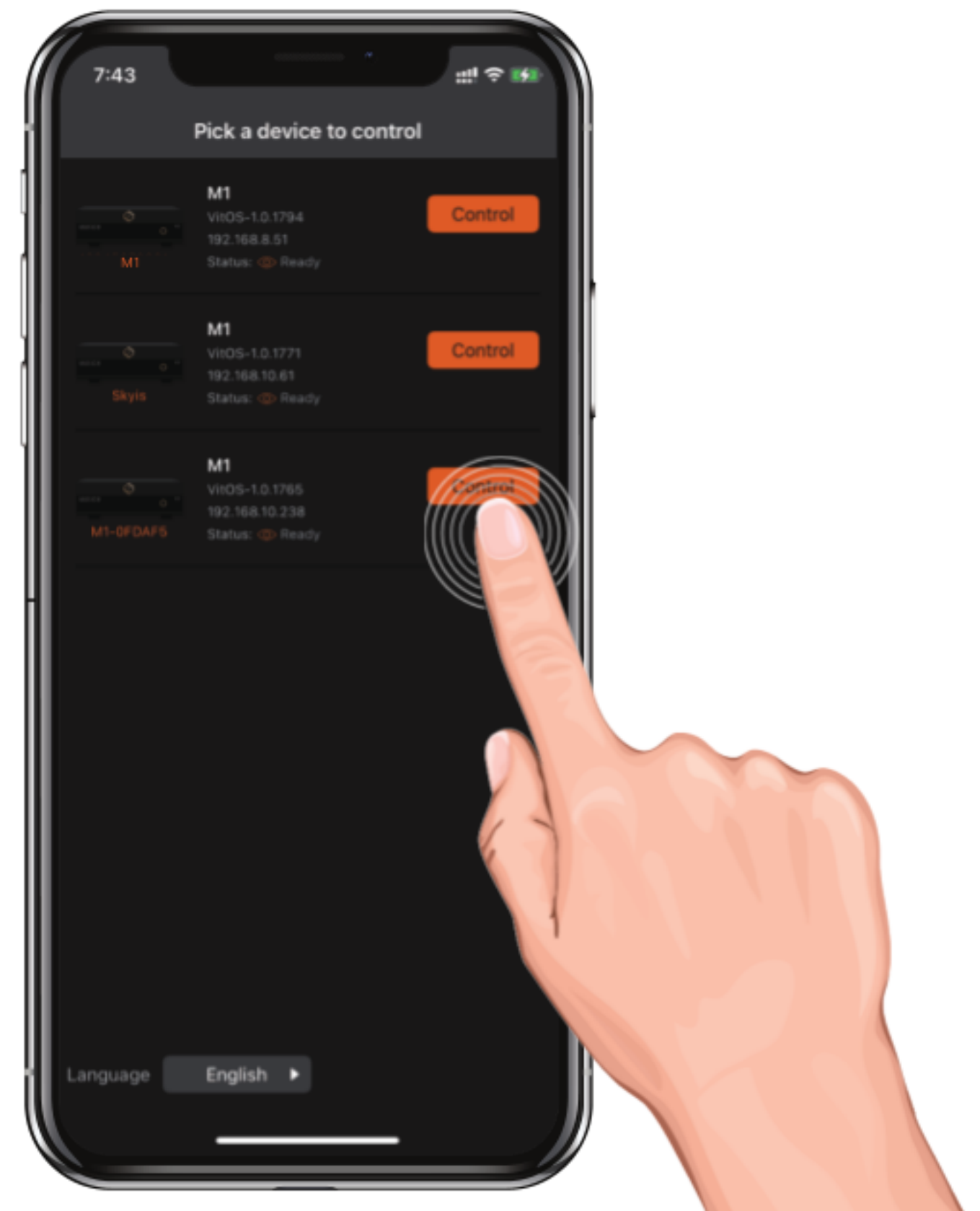
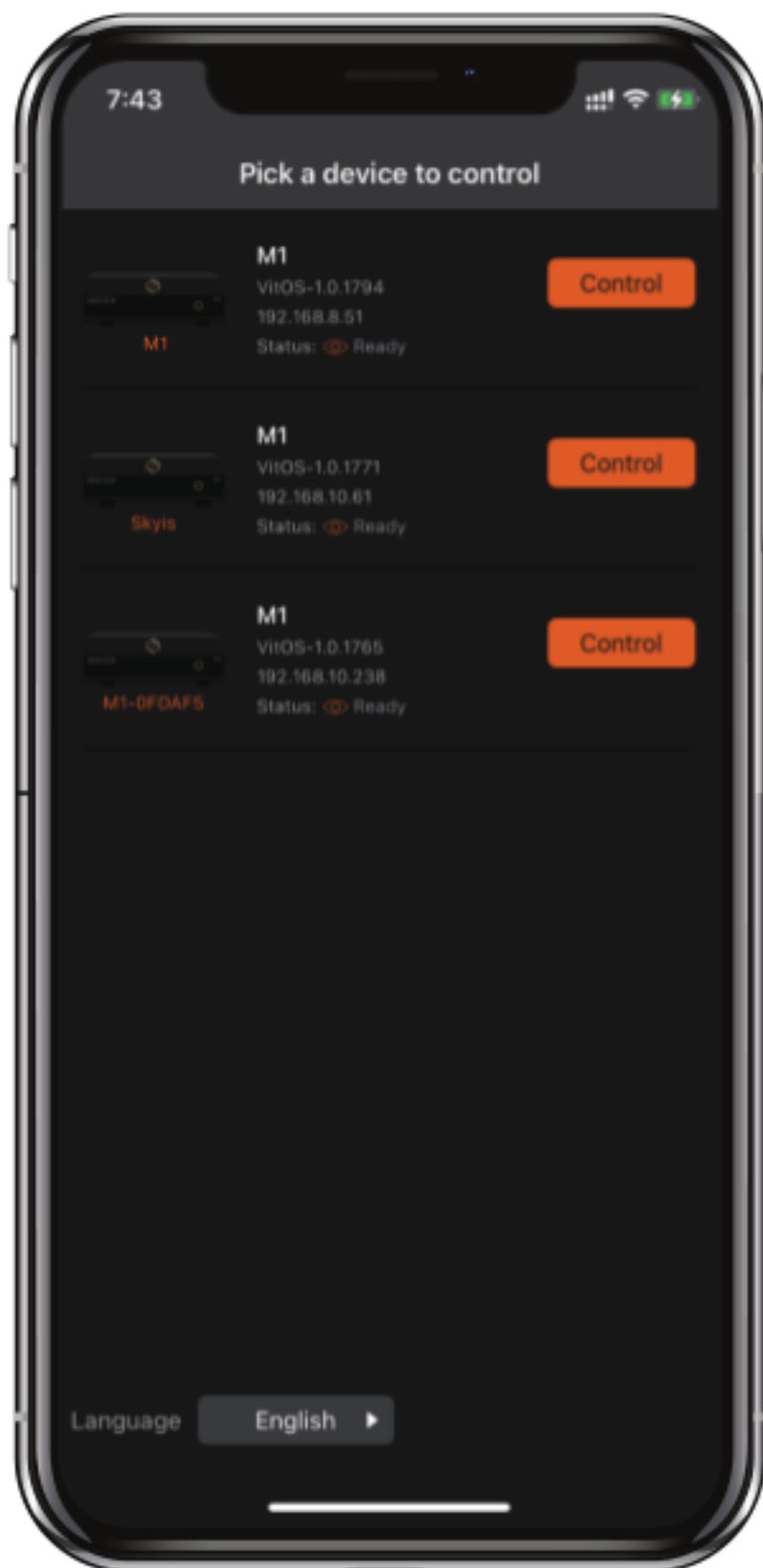

Device Search Guide

If the device cannot be found, click the "Help" button

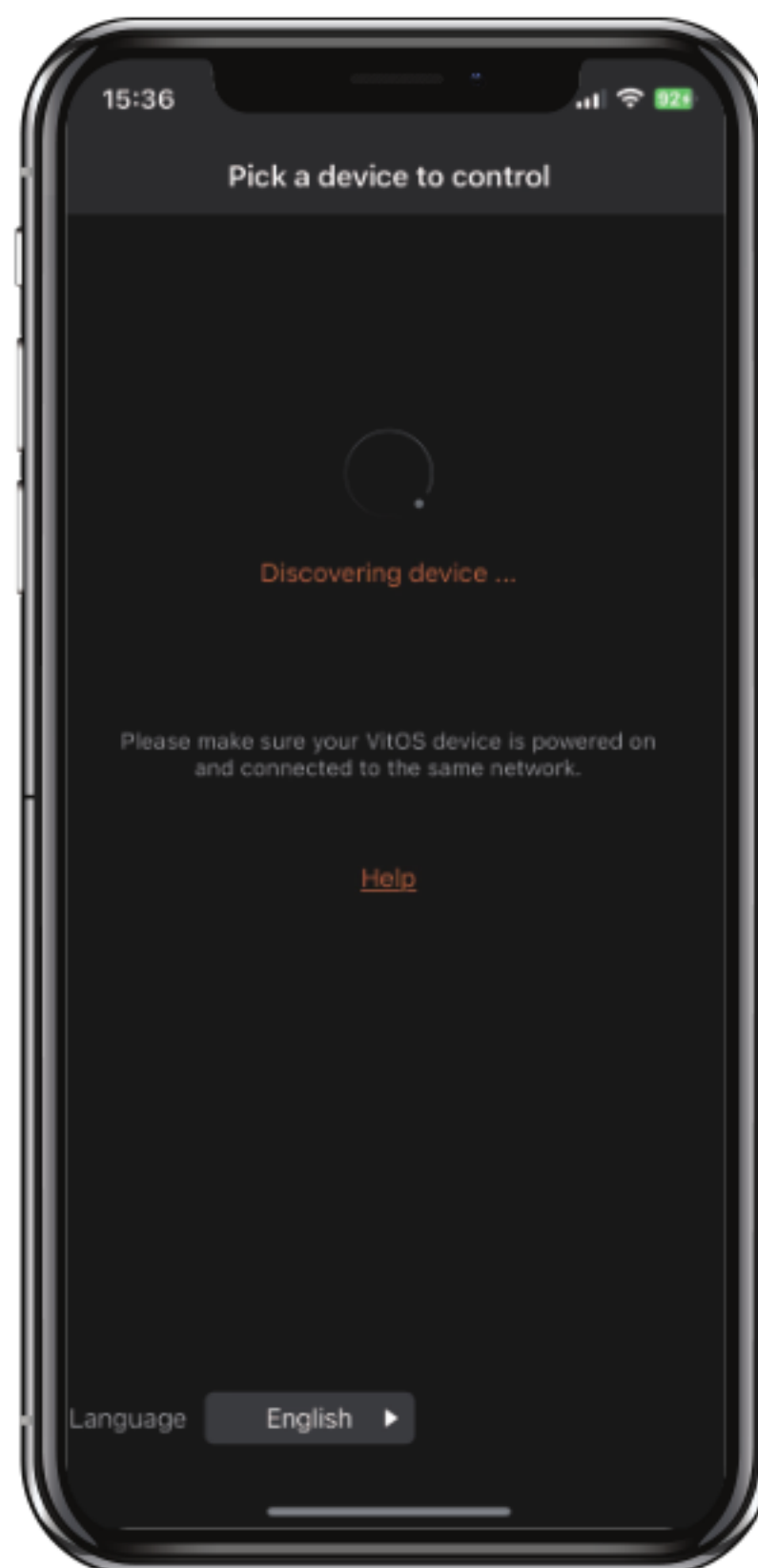
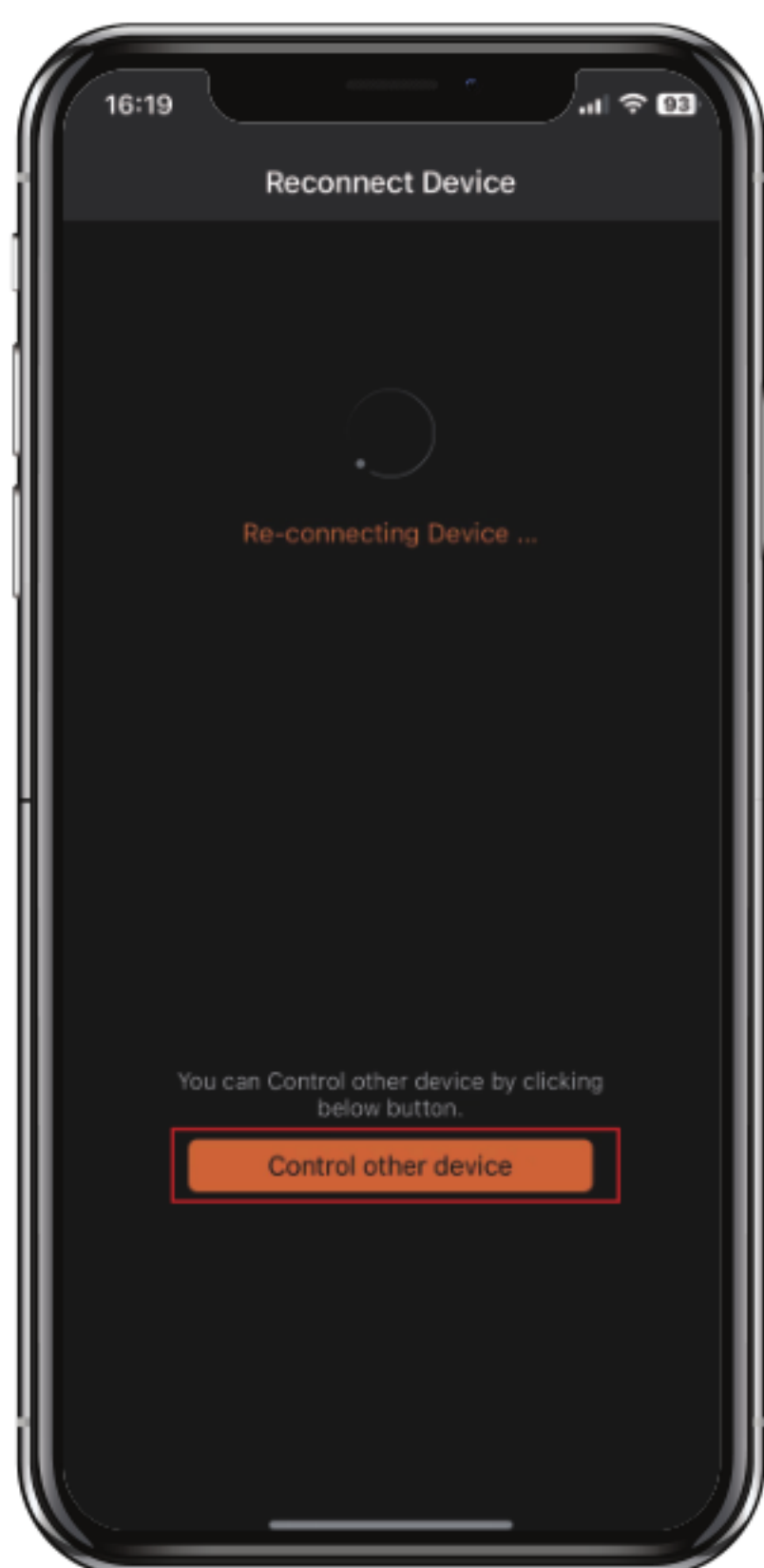

Enter the "Search Guide" interface, enter the IP address of the M1 / M1T device in the place marked in the lower interface, and then click "Connect"



Connect M1 / M1T successfully, and enter the VitOS Orbiter Use functions from side menu

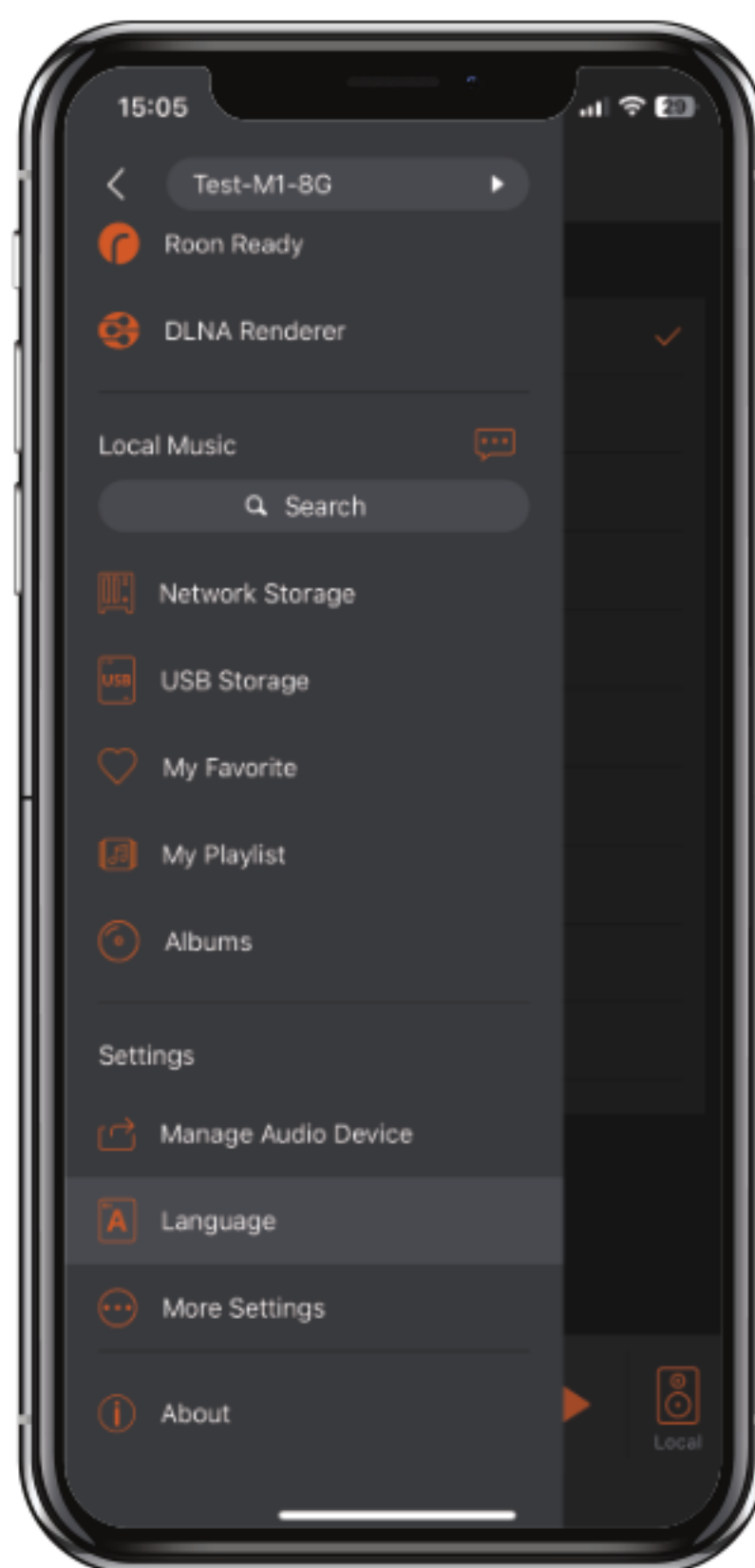
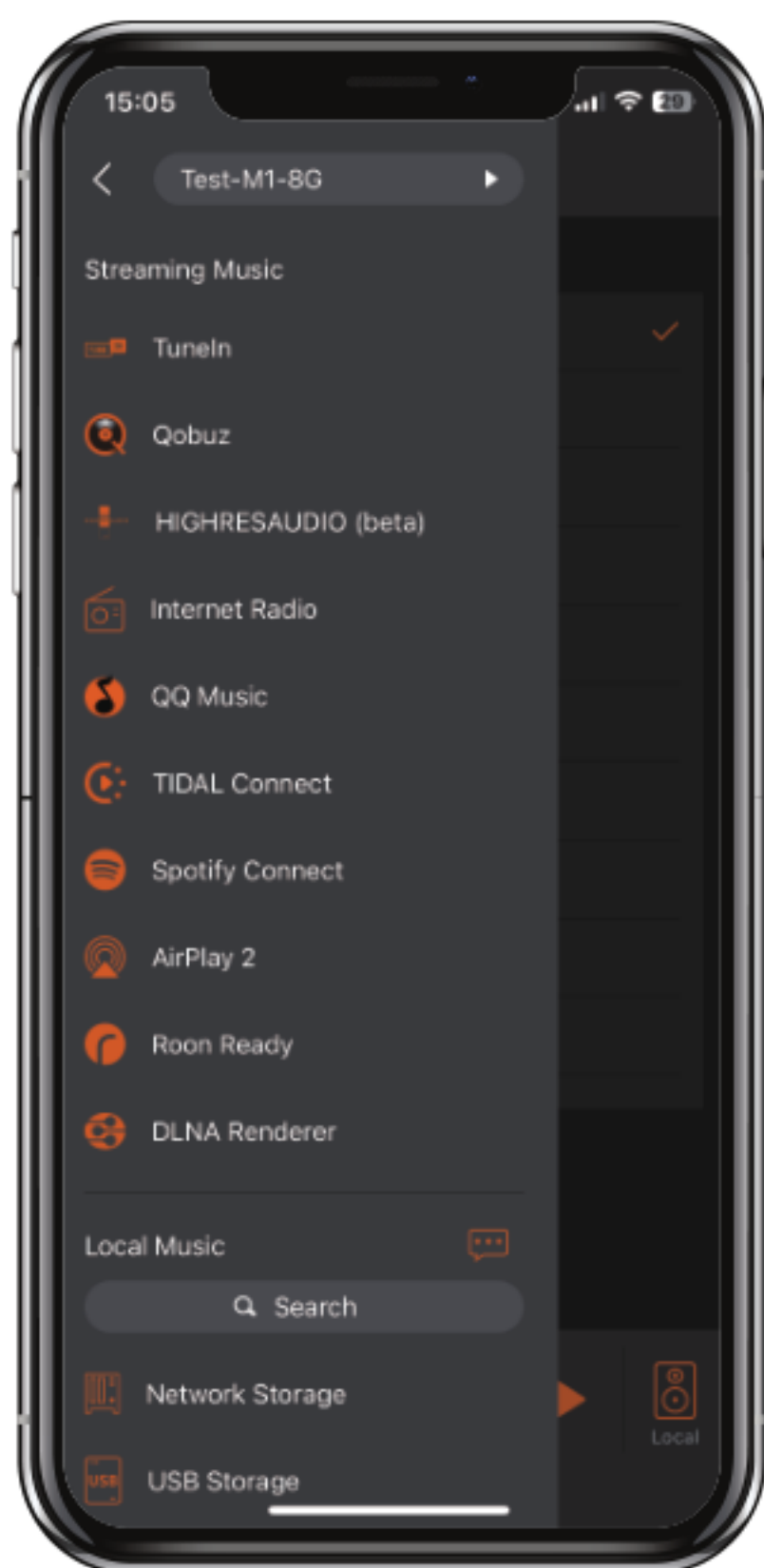



SILENT ANGEL

Trademark Attribution Notice

Windows is a trademark or registered trademarks of Microsoft Corporation in the United States and other countries. iOS is a trademark or registered trademark of Cisco in the U.S. and other countries. Android is a trademark of Google LLC, registered in the U.S. and other countries. Mac and macOS are trademarks of Apple Inc., registered in the U.S. and other countries. Apple is a trademark of Apple Inc., registered in the U.S. and other countries.