



Streaming Integrated Amplifier

Omnia A300
User's Manual

Table of Contents

FCC NOTICE - DECLARATION OF CONFORMITY INFORMATION	2
EU DECLARATION OF CONFORMITY.....	3
SAFETY INSTRUCTIONS	4
WHAT'S IN THE BOX.....	7
QUICK SETUP GUIDE.....	8
WIRELESS AUTO SETUP.....	9
CONTROLLING MULTIPLE A300 AND RE-STREAMING.....	14
WIRELESS MANUAL SETUP	19
INTRODUCTION	20
TECHNICAL HIGHLIGHTS	20
LISTENING OPTIMIZATION	22
IDENTIFICATION OF CONTROLS.....	23
DISPLAY SCREEN	27
DISPLAY MENU	28
NUPRIME EQ SETTINGS	29
REMOTE CONTROL	29
SPECIFICATIONS	32
NUPRIME'S LIMITED WARRANTY AND LIMITATION OF LIABILITIES	34

FCC NOTICE - DECLARATION OF CONFORMITY INFORMATION

This equipment has been tested and found to comply with the limits for a Class B digital device, pursuant to part 15 of the FCC Rules. These limits are designed to provide reasonable protection against harmful interference in a residential installation. This equipment uses and can radiate radio frequency energy and, if not installed and used in accordance with the instructions, may cause harmful interference to radio communications.

However, there is no guarantee that interference will not occur in a particular installation. If this equipment does cause harmful interference to radio or television reception, which can be determined by turning the equipment on and off, the user is encouraged to try to correct the interference by one or more of the following measures:

- Reorient or relocate the receiving antenna.
- Increase the separation between the equipment and receiver.
- Connect the equipment into an outlet on a circuit different from that to which the receiver is connected.
- Consult the dealer or an experienced radio/TV technician for help.

WARNING: Only peripherals complying with the FCC class B limits may be attached to this equipment.

Changes or modifications made to this equipment, not expressly approved by us or parties authorized by us could void the user's authority to operate the equipment. This device complies with part 15 of the FCC Rules. Operation is subject to the following two conditions: (1) This device may not cause harmful interference, and (2) this device must accept any interference received, including interference that may cause undesired operation.

EU DECLARATION OF CONFORMITY

CE Hereby, NuPrime Audio, Inc. declares that this device is in compliance with the essential requirements and other relevant provisions of Directive 2004/108/EC.

The manufacturer of this product is NuPrime Audio, Inc., 1712 Pioneer Ave. Ste 1817, Cheyenne, Wyoming 82001, USA.

The Authorized Representative for EMC and product safety is NuPrime Audio, Inc., 1712 Pioneer Ave. Ste 1817, Cheyenne, Wyoming 82001, USA.

For any service or guarantee matters please refer to the addresses given in separate service or guarantee documents.

For Customers in Europe



Disposal of Old Electrical & Electronic Equipment (Applicable in the European Union and other European countries with separate collection systems)

This symbol on the product or on its packaging indicates that this product shall not be treated as household waste. Instead it shall be handed over to the applicable collection point for the recycling of electrical and electronic equipment. By ensuring this product is disposed of correctly, you will help prevent potential negative consequences for the environment and human health, which could otherwise be caused by inappropriate waste handling of this product. The

recycling of materials will help to conserve natural resources. For more detailed information about recycling of this product, please contact your local Civic Office, your household waste disposal service or the shop where you purchased the product.

SAFETY INSTRUCTIONS

There are two categories of Safety Instructions included in this manual:

- Product Warnings, (i.e., what must never be done to assure avoiding those hazards that could cause bodily injury or property damage); and
- User Directions (i.e., what must always be done to assure the safe use of your device).

The Safety Instructions contained in this manual have been categorized in accordance with the seriousness of the potential hazards through the use of Signal Words. Those Signal Words, and their intended meanings, are as follows:

DANGER: Indicates that a failure to observe the Safety Instructions could result in death or catastrophic bodily injury.

WARNING: Indicates that a failure to observe the Safety Instructions could result in serious bodily injury.

CAUTION: Indicates that a failure to observe the Safety Instructions could result in minor bodily injury or property damage.

NOTE: Designates important information that relates to activities and/or conditions that might result in loss of data and/or damage to your device.

Safe Use and Operation of Your Device

This equipment emits stray RF energy and will interfere with the reception of signals by airborne electronic navigational devices or medical devices. Do not operate this equipment near any sensitive medical devices.

WARNING: Use only grounded AC power cords.

Always immediately disconnect the power to the equipment in the event the device emits an unusual odor or sound or generates smoke.

WARNING: Never attempt to disassemble, repair or make any modification to your device. Disassembly, modification or any attempt at repair could cause bodily injury or property damage, as well as damage to the device itself.

WARNING: Your device is not a toy. Never allow children to play with your device. Misuse, rough or improper handling of your device by children could result in serious bodily injury for any of the enumerated safety warnings in this manual. In addition, always keep all accessories and components out of the reach of small children as small parts might present a choking hazard. Seek immediate medical attention if choking occurs or if any small part has been swallowed.

CAUTION: Never raise the sound volume level too high when using your device with earphones. An excessive sound volume level could cause damage to your hearing.

WARNING: To reduce the risk of fire or electric shock, do not expose the unit to moisture or water.

Do not allow foreign objects to get into the enclosure. If the unit is exposed to moisture, or a foreign object gets into the enclosure, immediately disconnect the power cord from the wall.

Take the unit to a qualified service person for inspection and necessary repairs.

Read all the instructions before connecting or operating the component.

Keep this manual so you can refer to these safety instructions.

Heed all warnings and safety information in these instructions and on the product itself. Follow all operating instructions.

Do not use this unit near water.

You must allow a minimum 10 cm or 4 inches of unobstructed clearance around the unit. Do not place the unit on a bed, sofa, rug, or similar surface that could block the ventilation openings. If the unit is placed in a bookcase or cabinet, there must be ventilation of the cabinet to allow proper cooling.

Keep the component away from radiators, heat registers, stoves, or any other appliance that produces heat.

The unit must be connected to a power supply only of the type and voltage specified on the rear panel. Connect the component to the power outlet only with the supplied power supply cable or an exact equivalent. Do not modify the supplied cable.

Do not route the power cord where it will be crushed, pinched, bent, exposed to heat, or damaged in any way. Pay particular attention to the power cord at the plug and where the cord exits the back of the unit.

The power cord should be unplugged from the wall outlet during a lightning storm or if the unit is to be left unused for a long period of time.

Immediately stop using the component and have it inspected and/or serviced by a qualified service agency if:

- The power supply cord or plug has been damaged.
- Objects have fallen or liquid has been spilled into the unit.
- The unit has been exposed to rain.
- The unit shows signs of improper operation.
- The unit has been dropped or damaged in any way

WHAT'S IN THE BOX

Main power cord	x1
Metal remote-control	x1
USB Cable 1m	x1
Optical audio cable Toslink 1m	x1
User manual	x1
Wi-Fi 5G & Bluetooth antenna	x2

NOTE

Follow the Quick Setup Guide to help you get started with your A300.

SAVE THE PACKAGING

Please save the box and the packaging that came with the A300. Should you move or need to transport your A300, this is the safest container to use.

FACTORY RESET

A300 can be restored to factory default settings by pressing and holding the RED button at the rear panel for 5 seconds.

QUICK SETUP GUIDE

Your A300 can be connected to your home network via a wired or wireless connection. It can also be used as a non-network Integrated Amplifier with USB, optical, analog (AUX) and IIS inputs.

IMPORTANT!

- For wired and wireless connection to be established, ensure that a broadband router that supports Ethernet and Wi-Fi standards is set up and available.
- Use tablets, smartphones, and other applicable devices that support iOS (Apple) or Android operating systems as mobile device controllers. These devices are not supplied with your A300.
- Download and install the Omnia Receiver App to your iOS device from the App Store or your Android device from the Google Play Store.
- If you are using Windows USB audio as one of the sources, download the device driver directly from the NuPrime Official Website (<https://www.nuprimeaudio.com>) Omnia A300 product page.
- Always ensure that your A300 is updated with the latest firmware. Go to the A300 product page at nuprimeaudio.com for firmware update information.

WIRED CONNECTION

Using an ethernet cable (not supplied), connect one end to A300's LAN port and the other end directly to your wired network or router.

POWER UP A300

Turn on A300. Please wait 3 minutes for it to boot up. Press the red button on the rear panel once (do not press and hold).

WIRELESS AUTO SETUP

① When you first launch the Omnia Receiver app, it will automatically search for the Omnia A300. If it does not detect any compatible devices, the app will show the following screen:

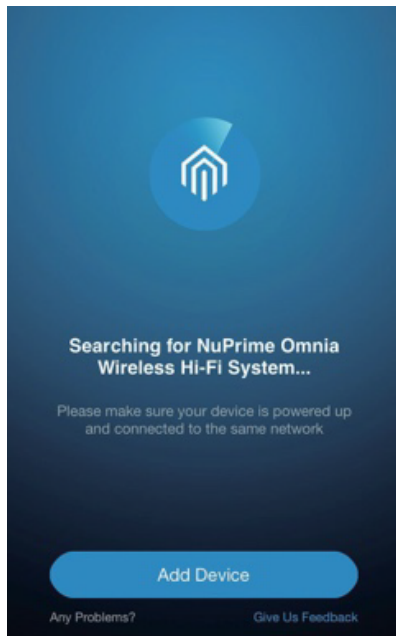

② If you haven't pressed the red button on the rear panel once (do not press and hold) after power on, do it now.

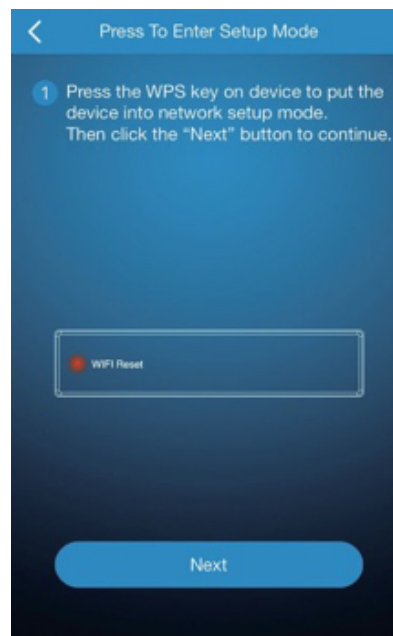

③ Select Omnia A300 device (the Omnia Receiver app called all receiving devices as Speaker).



④ Configure Wi-Fi setup on Omnia A300 by selecting the same SSID of the Wi-Fi network on your mobile device.

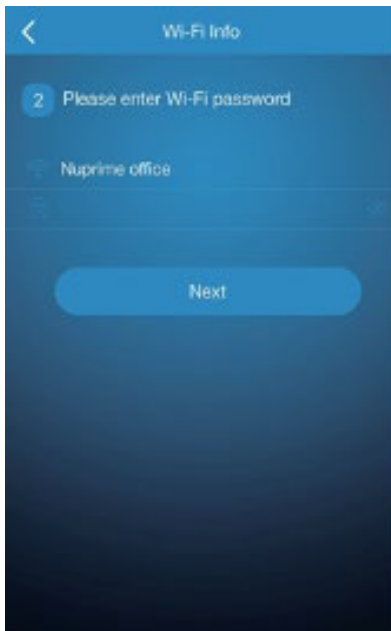

⑤ Wait for the A300 to connect to the selected Wi-Fi network.

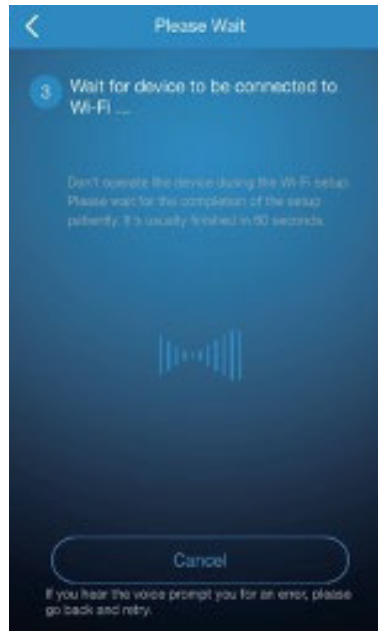

⑥ Device is connected.

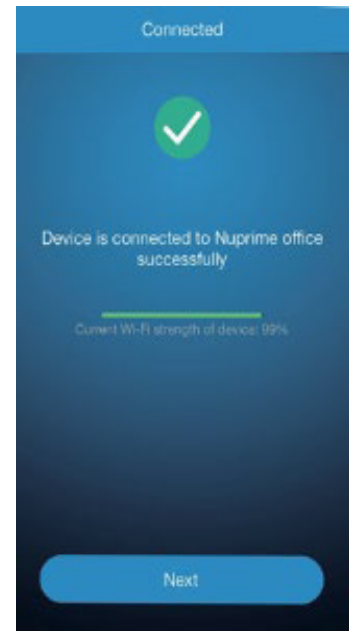

⑦ Optionally login to Amazon Alexa.

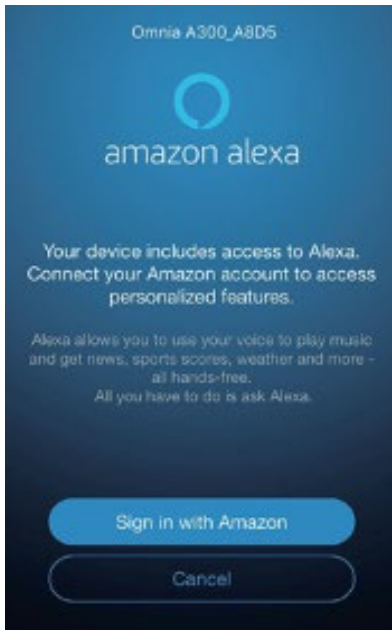

⑧ Name your device.

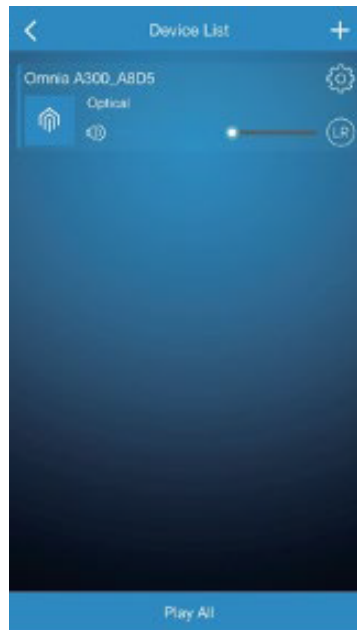

⑨ Pick from a list of standard room names or create your own.



10 Play music using the NuPrime Omnia App as a functional remote control.

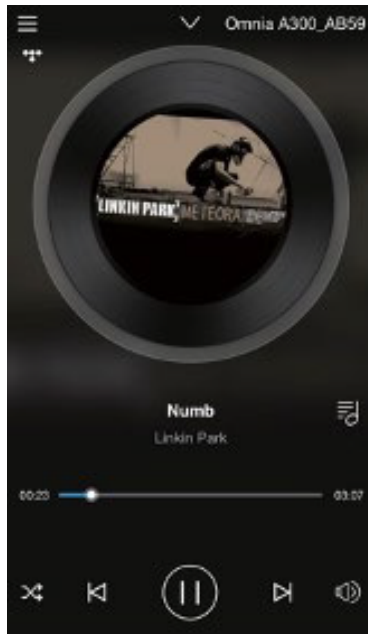

11 Select "Add More Services" to hide or show the list of music services. If you intend to use the physically connected inputs as source, hide the unused music services. Most of these services can be entirely controlled by the Omnia Receiver app. For Spotify, you will need to have their app installed, and first use their app to play to the Omnia Receiver. You can then control the playlist from the Omnia Receiver app

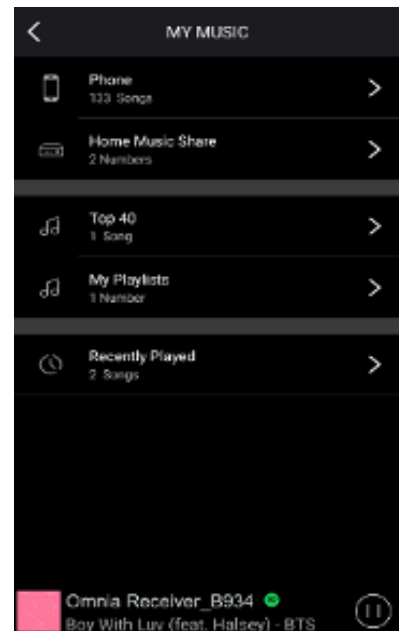
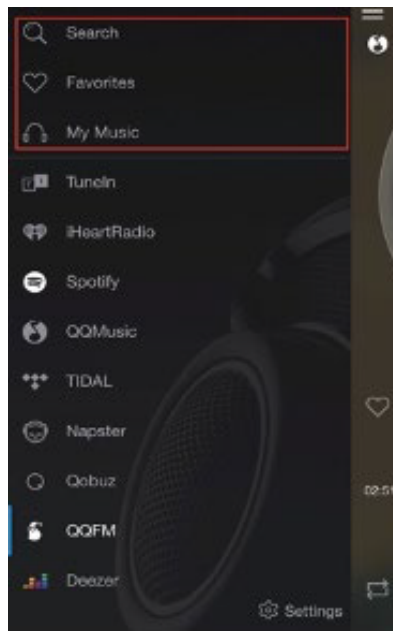

12 Select "Add More Services" to hide or show the list of music services. If you intend to use the physically connected inputs as source, hide the unused music services. Most of these services can be entirely controlled by the Omnia Receiver app. For Spotify, you will need to have their app installed, and first use their app to play to the Omnia Receiver. You can then control the playlist from the Omnia Receiver app.

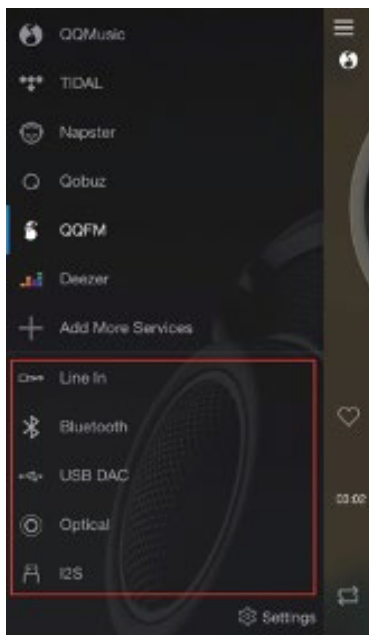

13 Select input source if you are not using streaming services.

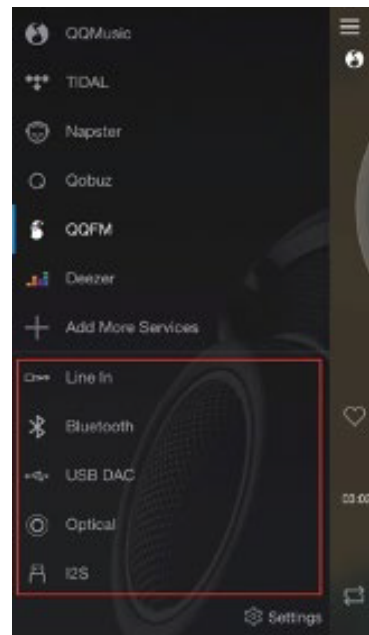

14 The streaming music service connect Now you could start to enjoy all of the streaming music services.

Spotify Connect



Use your phone, tablet or computer as a remote control for Spotify. Go to [spotify.com/connect](https://www.spotify.com/connect) to learn how.

The Spotify Software is subject to third party licenses found here:
<https://www.spotify.com/connect/third-party-licenses>

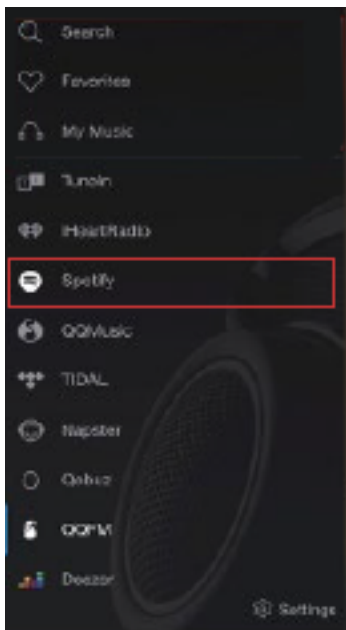

2. Set up Spotify APP

- You'll need a phone, laptop, or tablet with the latest Spotify app.
- Add another device that supports Spotify or has the app (like a speaker or laptop).
- Connect both devices to the same Wi-Fi network, and log in to Spotify.
- Fire up the Spotify app on your phone, laptop, or tablet.
- Play a song and select Devices Available.
- Select your device and start listening.

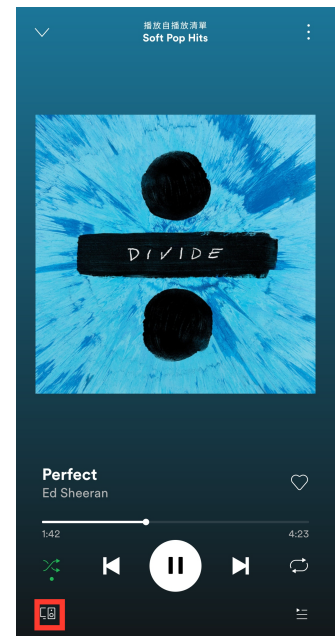
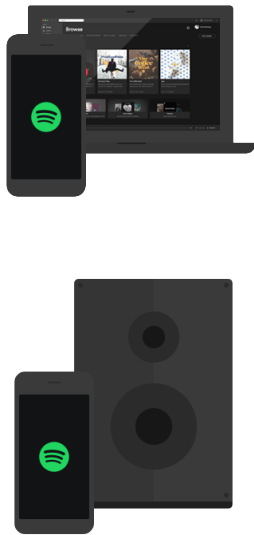

Note: NuPrime Omnia App will temporarily lose connection to the A300 as the unit reboots during the upgrade process. Please quit the App and reopen once the upgrade has been completed.

CONTROLLING MULTIPLE A300 AND RE-STREAMING

- ① Each A300 is independently controlled by the Omnia Receiver app and can be accessed from the Device List. You can assign different names to each receiver, choose what songs each of them is playing, or even group them to play the same music. To group devices, press and hold a device icon and drag towards another device or existing group.

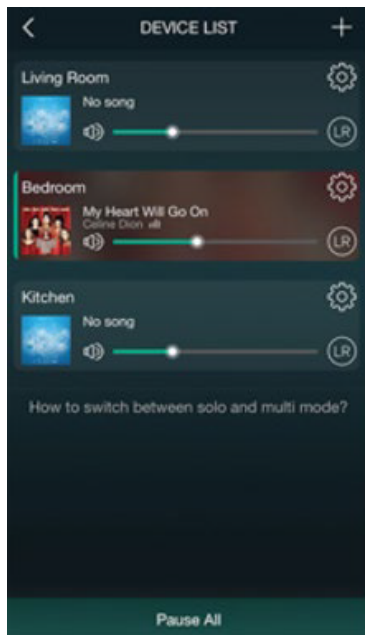

- ② Select a group or single device for playing music.

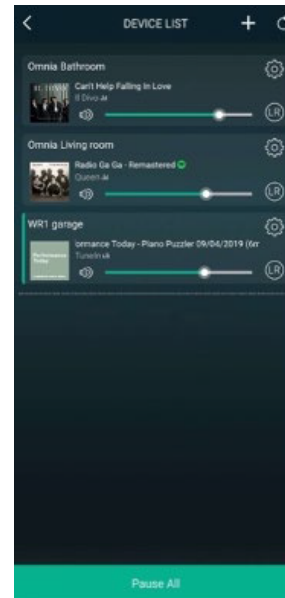
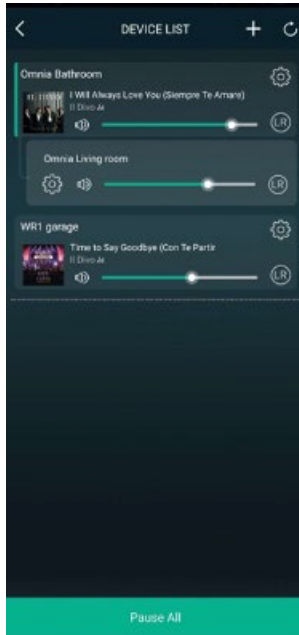

GROUP'S DEVICE MASTER AND RE-STREAMING

When multiple devices are grouped, the first device in the group act as the master for music source. Re-streaming happens when the master device receives music from Bluetooth, analog or optical input and streams to all other receivers within the group.

WIRELESS MANUAL SETUP

1. Select your A300's unique network ID* from the Wi-Fi Setup connection settings menu of your tablet, smart phone or computer and join it.
2. "...Control Panel" menu window should automatically open. If not, open the web browser of your device and visit <http://10.1.2.3>.
3. Select "Configure Wi-Fi" from the "...Control Panel" menu. Select your network or applicable wireless network name (SSID) from the "Configure Wireless" drop down menu.
4. Enter your network's Wireless Password (Passphrase, WEP/WAP key as applicable) in the field "Enter password or key (if protected)".
5. Select a "Player name" from the drop-down list or use the on-screen keyboard to create a customized room name in the field "Custom name".
6. Select "Update" to save all your settings and complete the set-up connection of your A300. Do not forget to go back to the Wi-Fi Settings section of your device to confirm that it is reconnected to the correct Wi-Fi network.

INTRODUCTION

The NuPrime Omnia A300 is a full-featured multi-zone streaming integrated amplifier designed for audiophiles who required high-resolution digital sources from local music libraries as well as network streaming music. A summary of the following features put A300 ahead of its peers:

- Amplifier capable of 2 x 150W @ 8 ohms and 2 x 200W @ 4 ohms power
- Wi-Fi 24-bit/192kHz and Bluetooth 5.0 aptX HD streaming
- Multiple digital and analog inputs, with up to IIS 32-bit/768kHz, USB 24-bit/384kHz, and DSD256 decoding
- Supports all major online streaming services, and network DLNA streaming

The free iOS and Android app allow you to easily control your smart music system and select your source music and group destination speakers (including receiving streamers).

TECHNICAL HIGHLIGHTS

A combination of high-power Class-D amplifier, 64-bit quad-core Arm Cortex-A53 processor, NuPrime proprietary SRC chip, Cirrus Logic CS43131 DAC, plus other audiophile-grade components enable the Omnia A300 to achieve world class performance above its peers.

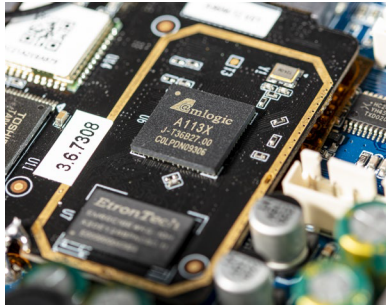

Amlogic A113X
64-bit quad-core Arm Cortex-
A53 processor for high resolution
wireless streaming

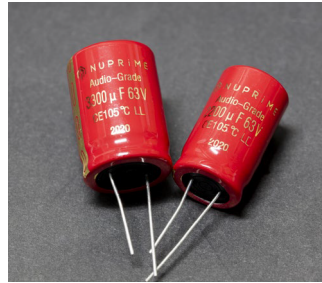

Audiophile-grade
components and noise
filter

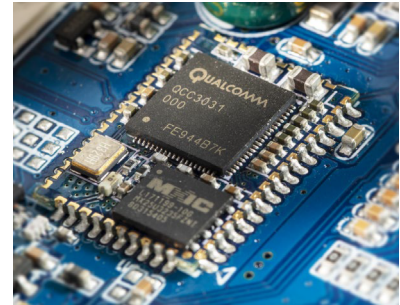

Bluetooth Wireless HD
Qualcomm aptX HD supports
24-bit music quality over
Bluetooth

The Omnia A300 utilizes a compact yet powerful Class-D amplifier capable of signal bandwidth up to 100kHz with advanced integrated feedback design and error correction for very low noise and distortion. The Cirrus Logic CS43131 combines a next-generation, low power audio DAC with a high-fidelity headphone amplifier to provide a superior system-level audio performance. The onboard low noise, ground-centered headphone amplifier provides proprietary AC impedance detection to support headphone fingerprinting to provide a consistent and transparent audio experience for the end user regardless of transducer impedances or frequency responses.

LISTENING OPTIMIZATION

- A user-selectable switch allows the matching to 4Ohms or 8Ohms load speakers. We recommend the 8R setting for most use cases except for speakers with very low impedance (i.e., lower than 4Ohms) for a more natural sound. Therefore, even if you have a 4 ohms nominal impedance speaker, you should try to listen with 8R settings or compare and settle down on one you prefer.
- The linear and neutral sonic bias of the A300 makes it suitable for a wide range of speakers and sources. The EQ presets and loudness (bass enhancement) selections tuned via a high-speed DSP allows further sound tailoring to the system and music.

IDENTIFICATION OF CONTROLS

Rear Panel Illustration

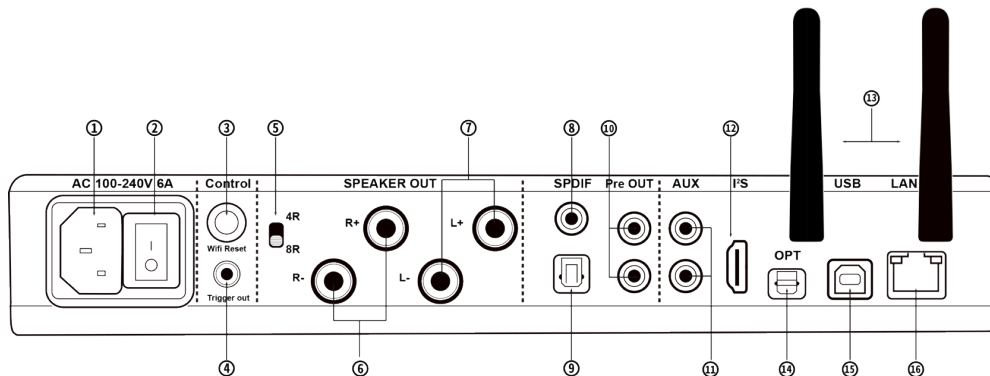

1. POWER SOCKET
 - Connect to AC input.
2. POWER SWITCH
 - ON/OFF Switch.
3. FACTORY RESET/ Wi-Fi RESET BUTTON
 - Push and hold the button for 5 seconds to restore to factory settings.
 - If Wi-Fi is disconnected from A300, push once for A300 to search the Wi-Fi signal again.
4. TRIGGER OUT
 - The +12V TRIGGER OUT is used for controlling external equipment equipped with a +12V trigger input. Use a mono cable with a 3.5mm male plug.
5. SPEAKER IMPEDANCE SWITCH
 - Use 4R / 8R switch to match the 4 Ohm or 8 Ohm nominal impedance of your speaker (consult your speaker specification). Please set this switch before turning on A300.

6. Right SPEAKER OUTPUTS
 - Connect A300 Right speaker terminals marked 'R+' and 'R-' to the corresponding '+' and '-' terminals of your designated right speaker.
7. Left SPEAKER OUTPUTS
 - Connect A300 left speaker terminals marked 'L+' and 'L-' to the corresponding '+' and '-' terminals of your designated left speaker.
8. COAXIAL SPDIF OUTPUT
 - Connect to the corresponding coaxial digital input source device.
9. SPDIF OPTICAL OUTPUT
 - Connect to corresponding optical digital input of sources such as DAC and receivers.
10. PRE-OUT
 - Use stereo RCA cable to connect PRE-OUT to the corresponding analog audio input of compatible devices such as amplifier, receiver or active speaker.
11. AUX INPUT
 - Input for line-level sources such as CD player, tuner, or any compatible devices. Use stereo RCA cable to connect to the source device's left and right audio outputs.
12. IIS INPUT
 - Input for compatible NuPrime devices such as CD player or music server. Use HDMI cable to connect the source device.
 - Support the sampling rate to PCM 32bit/768kHz and DSD 256 data streams.
13. ANTENNA (Wi-Fi & Bluetooth)
 - Used for Wi-Fi & Bluetooth connections.
 - Dual band (2.4GHz and 5GHz).
 - Qualcomm Bluetooth 5.0 (aptX HD).

14. OPTICAL INPUT

- Connect to corresponding optical digital output of devices such as CD player, TV set-top-box, and digital music player.
- Support sampling rate to PCM 192KHz including DoP format DSD64.

15. USB INPUT

- Connect to USB audio output from a computer, tablet, music player or NAS. Support decoding PCM up to 384kHz & DSD up to DSD256.

16. LAN

- RJ45 ethernet connection for wired network.

ATTENTION!

Please ensure that the A300 is powered off or unplugged from the mains power outlet before making any connections.

Front Panel Illustration

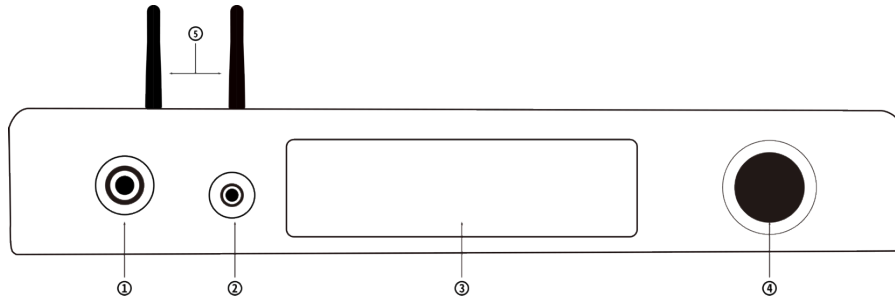

1. The 6.3mm stereo jack
2. The 3.5mm stereo jack
3. Display
4. Function Control knob
5. Dual-band antenna

DISPLAY SCREEN

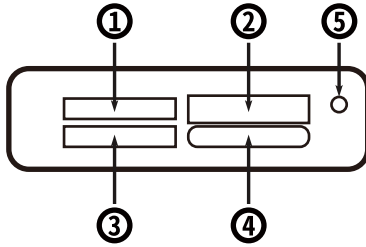

1. Source indicator.
2. Volume setting from 0dB to -99dB level.
3. Wi-Fi or Bluetooth indicator.
4. EQ setting display
5. Amber LED lights up when A300 is in standby mode.

DISPLAY MENU

Power on

NuPrime logo



Standby

Amber LED lights up when Function Control knob is pressed for 5 seconds



Display Brightness

Press the Remote Control "MUTE" button for 3 seconds to adjust the backlight level from 00 to 10



Source Selection

A300 supports Wi-Fi, Bluetooth, AUX, IIS, Optical, and USB inputs.

- Press the Function Control knob to toggle between the inputs.
- Use the Remote Control to select any input directly.



AUX In



IIS In



Optical In

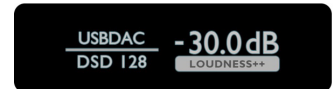

USB In



Bluetooth In

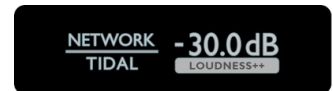

USB In

NUPRIME EQ SETTINGS

NuPrime proprietary EQ settings allow the users to choose their listening experience according to music preferences and audio equipment matching. Despite its name, Loudness settings create warmth and impact for the listener instead of louder sound.

Repeatedly pressing the Loudness button will cycle through the following EQ settings: Flat, Loudness, Loudness+, Loudness++, Rock, Jazz, Pop, Classic

REMOTE CONTROL

1. Power ON/Standby button. To power off A300, use the AC switch.
2. NuPrime proprietary EQ settings.
3. Preset channels for favorite music services.
4. Source input selection
5. Multi-function control for music playback

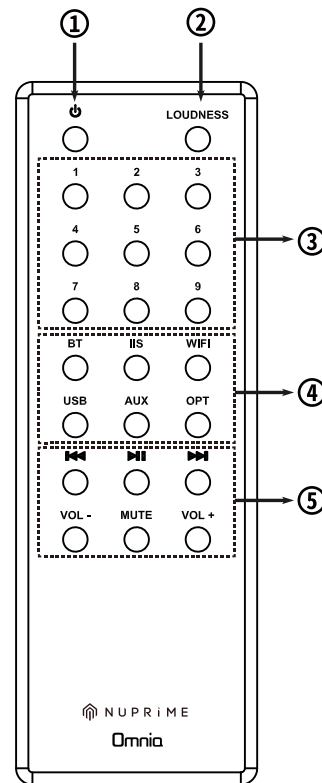

Setting the Remote Control Preset Keys 1 to 9

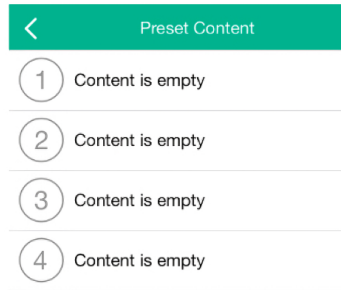
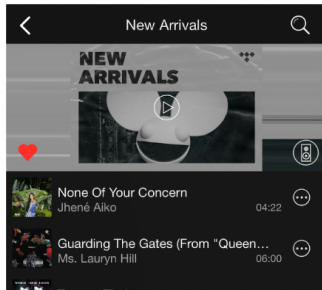

If any of these Presets have been programmed, they will show the name of a playlist.

Setting the Preset Channels

1. On the App, select any playlist that you want to set on the Remote Control keys 1 to 9.
2. Only the playlist that has a speaker icon on the top right corner can be programmed as a Preset. Select the speaker icon and a Present Content box will pop up.
3. Select any of the 1 to 9 and confirm that you want to link this playlist to the corresponding Remote Control Preset Key.

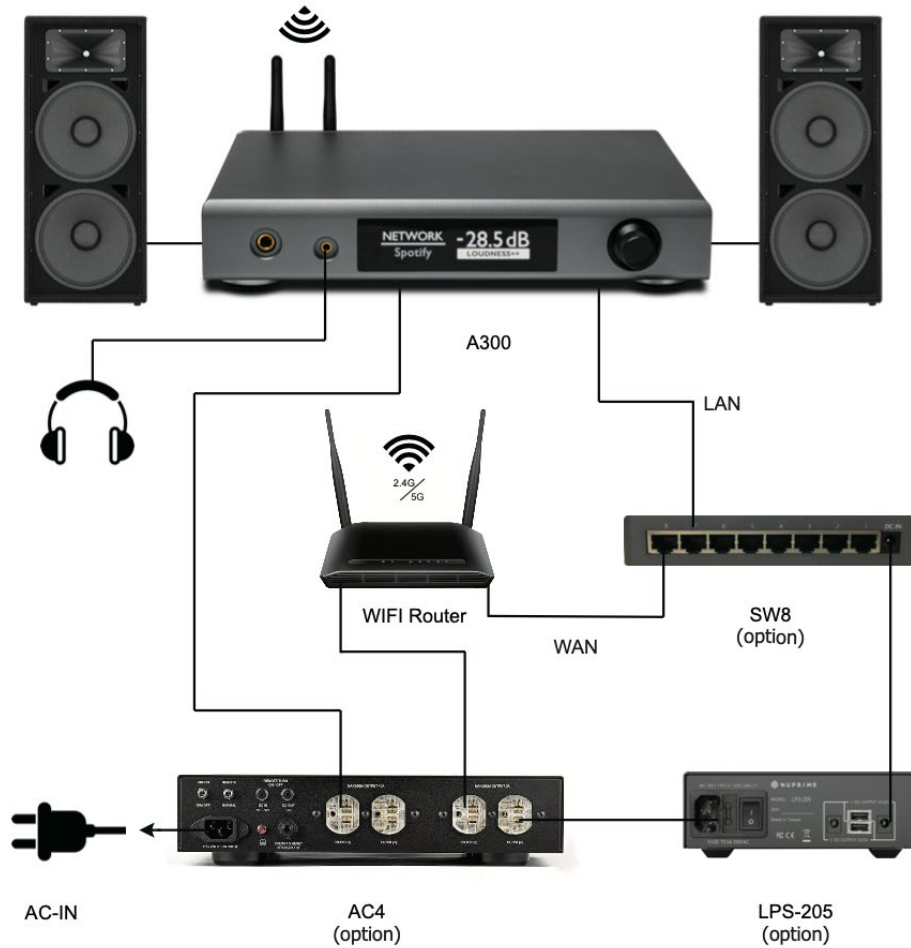

SPECIFICATIONS

Amplifier

- Power: 150W @ 8 ohms; 200W @ 4 ohms (both channels driven)
- THD:
 - <0.02% (AUX IN, 1W, @ 8 & 4 ohms)
 - <0.01% (OPT IN, 1W, @ 8 & 4 ohms)
- Signal-to-Noise Ratio: >95 dB (Digital input, 10W out @ 8 ohms)
- Clipping Power: >230W (1kHz @ 4 ohms, both channels driven)
- Frequency Response: +0.6 dB/-1dB (12 Hz - 22 kHz)
- Channel Separation: >85dB (1 kHz AUX); >105 dB (10 kHz Digital)
- Input Sensitivity:
 - 0.85V (AUX & OPT) for 100W @ 8 ohms
 - 0.75V (AUX & OPT) for 100W @ 4 ohms
- Standby Power: <0.5W

DAC & Wireless

- Bit Depths: 16-32 bit
- Streaming Audio Processing Engine: up to 192KHz / 24-bit
- IIS/DSD HDMI Input: PCM up to 768KHz/32Bit and DSD up to DSD256
- USB PCM/DSD Input: PCM up to 384kHz/32Bit and DSD up to DSD256
- Optical S/PDIF Input: PCM up to 192KHz and supporting DoP format DSD64
- Optical & Coaxial digital outputs
- Analog Pre-Out
- Bluetooth: Two-Way (Receive and Headphone modes)
- Streaming Technologies: Bluetooth 5.0 (aptX HD), and DLNA
- Network Connectivity: Gigabit Ethernet RJ45, 802.11 b/g/n Wi-Fi
- Streaming Services: Amazon Music, Deezer, iHeartRadio, Qobuz, QQ Music, Spotify, TIDAL, TuneIn, Napster, Ximalaya

Dimension and Weight

- Product Dimensions (W x H x D): 280 x 55 x 250 mm (includes feet and extended rear panel terminals)
- Product Weight: 3 kg (6.6 lbs.)
- Package Dimensions (W x H x D): 440 x 100 x 340 mm
- Shipping Weight: 5 kg (11 lbs.)

All specs are measured according to IHF 202 CEA 490-AR-2008 standard. THD is measured using AP AUX 0025 passive filter and AES 17 active filter.

All artist and product names, logos and brands are property of their respective owners. Names, images or likenesses are copyrights of their respective owners.

Specifications and supported cloud services are subject to change without notice. Please refer to www.nuprimeaudio.com for latest information.

NUPRIME'S LIMITED WARRANTY AND LIMITATION OF LIABILITIES

ADDITIONAL RIGHTS

For consumers, who are covered by consumer protection laws or regulations in their country of purchase or, if different, their country of residence, the benefits conferred by this warranty are in addition to all rights and remedies conveyed by such consumer protection laws and regulations. This warranty does not exclude, limit or suspend any rights of consumers arising out of nonconformity with a sales contract. Some countries, states and provinces do not allow the exclusion or limitation of incidental or consequential damages or allow limitations on how long an implied warranty or condition may last, so the limitations or exclusions described below may not apply to you. This warranty gives you specific legal rights, and you may also have other rights that vary by country, state or province. This limited warranty is governed by and construed under the laws of the country in which the product purchase took place.

LIMITED WARRANTY

For a period of ONE (1) YEAR from the date of retail purchase by the original end-user purchaser ("Warranty Period"), NuPrime warrants (in) this product against defects in materials and workmanship, and (ii) that each Product, unmodified and under normal use and conditions, will substantially comply with NuPrime' applicable written technical documentation for the Product. NuPrime reserves the right to make substitutions and modifications from time to time in the specifications of Products sold by NuPrime, provided that such substitutions or modifications do not materially affect overall Product performance.

If a hardware defect exists and a valid claim is received within the Warranty Period, at its option and to the extent permitted by law, NuPrime will (1) repair the hardware defect at no charge, using new or refurbished replacement parts, (2) exchange the product with a product that is new or which has been manufactured from new or serviceable used parts and is at least functionally equivalent to the original product, or (3) refund the purchase price of the product. NuPrime may

request that you replace defective parts with user-installable new or refurbished parts that NuPrime provides in fulfillment of its warranty obligation. A replacement product/part assumes the remaining warranty of the original product or ninety (90) days from the date of replacement or repair, whichever provides longer coverage for you. When a product or part is exchanged, any replacement item becomes your property and the replaced item becomes NuPrime's property. When a refund is given, your product becomes NuPrime's property.

OBTAINING WARRANTY SERVICE

If you purchased the product in the U.S., deliver the product, at your expense, to any NuPrime Service Center located in the U.S. If you purchased the product outside of the U.S., deliver the product to any NuPrime Authorized Importer in the country where you purchased the product. Be aware, however, that not all countries have NuPrime Authorized Service Providers ('NASP') and not all Authorized Service Providers outside the country of purchase have all parts or replacement units for the product. If the product cannot be repaired or replaced in the country it is in, it may need to be sent to a different country or returned to the country of purchase at your expense for repair or replacement. If you seek service in a country that is not the country of original purchase, you will comply with all applicable import and export laws and regulations and be responsible for all custom duties, V.A.T. and other associated taxes and charges. Where international service is available, NuPrime may repair or exchange defective products and parts with comparable products and parts that comply with local standards.

You can always deliver the product to NuPrime's U.S.A or Taiwan service center for obtaining warranty service, however, you may have to pay for shipping cost.

NuPrime may send you user-installable new or refurbished replacement product or parts to enable you to service or exchange your own product ("DIY Service"). Upon receipt of the replacement product or part, the original product or part becomes the property of NuPrime and you agree to follow instructions, including, if required, arranging the return of original product or part to NuPrime in a timely manner.

When providing DIY Service requiring the return of the original product or part, NuPrime may require a credit card authorization as security for the retail price of the replacement product or part and applicable shipping costs. If you follow instructions, NuPrime will cancel the credit card authorization, so you will not be charged for the product or part and shipping costs. If you fail to return the replaced product or part as instructed or the replaced product or part is not eligible for warranty service, NuPrime will charge the credit card for the authorized amount.

EXCLUSIONS AND LIMITATIONS

This Limited Warranty applies only to hardware products manufactured by or for NuPrime that can be identified by the "NuPrime" trademark, trade name, or logo affixed to them. The Limited Warranty does not apply to any non-NuPrime hardware products or any accessories, even if packaged or sold with NuPrime hardware. Non-NuPrime manufacturers, suppliers, may provide their own warranties. Other accessories distributed by NuPrime under the NuPrime brand name are not covered under this Limited Warranty. This warranty does not apply: (a) to damage caused by accident, abuse, misuse, misapplication, liquid contact, fire, earthquake, non-NuPrime products, or other external causes; (b) to damage caused by service performed by anyone who is not a NASP; (c) to a product or a part that has been modified without the written permission of NuPrime; (d) to consumable parts, such as batteries, or protective coatings designed to diminish over time unless failure has occurred due to a defect in materials or workmanship; (e) to cosmetic damage, including but not limited to scratches, dents, and broken plastic on ports; (f) to defects caused by normal wear and tear or otherwise due to the normal aging of the product; or (g) if any NuPrime serial number has been removed or defaced.

Important: Do not open the hardware product. Opening the hardware product may cause damage that is not covered by this warranty. Only NuPrime or a NASP should perform service on this hardware product.

This warranty and remedies set forth above are exclusive and in lieu of all other warranties, remedies and conditions, whether oral or written, express or implied. NuPrime specifically

disclaims any and all implied warranties, including, without limitation, warranties of merchantability and fitness for a particular purpose. If NuPrime cannot lawfully disclaim implied warranties under this limited warranty, all such warranties, including warranties of merchantability and fitness for a particular purpose are limited in duration to the duration of this warranty. No NuPrime reseller, agent, or employee is authorized to make any modification, extension, or addition to this warranty.

NuPrime is not responsible for direct, special, incidental or consequential damages resulting from any breach of warranty or condition, or under any other legal theory, including but not limited to lost profits, downtime, goodwill, damage to or replacement of equipment and property, any costs of recovering, reprogramming, or reproducing any program or data stored in or used with NuPrime products, and any failure to maintain the confidentiality of data stored on the product. NuPrime specifically does not represent that it will be able to repair any product under this warranty or make a product exchange without risk to or loss of programs or data.

Some states and provinces do not allow the exclusion or limitation of incidental or consequential damages or exclusions or limitations on the duration of implied warranties or conditions, so the above limitations or exclusions may not apply to you. This warranty gives you specific legal rights, and you may also have other rights that vary by state or province.

Proof of purchase in the form of a bill of sale or receipted invoice which is evidence that the unit is within the Warranty period must be presented to obtain warranty service.

Replacement as provided under this warranty is the exclusive remedy of the consumer. NuPrime shall not be liable for any incidental or consequential damages for breach of any express or implied warranty on this product. Except to the extent prohibited by applicable law, any implied warranty of merchantability or fitness for a particular purpose on this product is limited in duration to the duration of this warranty.



NUPRIME

beyond
ordinary