

DENON[®]

DENON HOME 400

Wireless Speaker

Owner's Manual



Accessories	4
Part names and functions	5
Front panel	5
Side panel	6
Rear panel	7
Placing	8
Wall or floor stand mounting	9
Powering your speaker	12
Getting the HEOS app	13

Setup

Setting up the HEOS app for the first time with a HEOS Built-in device	14
Adding the registration of HEOS Built-in devices in the HEOS app	15
Adding wired HEOS Built-in devices	15
Adding wireless HEOS Built-in devices	16
HEOS account	17

Playback

Playing from streaming music services	18
Selecting a room/device	18
Selecting the music track or station from music sources	19
Listening to the same music in multiple rooms	20
Grouping rooms	20
Ungrouping rooms	21
Grouping all rooms	22
Ungrouping all rooms	23
Listening to Internet Radio	24
Playing music stored on your mobile device	24
Playing back files stored on a PC or NAS	24
Playing music from the AUX input	25
Playing music from a USB flash drive	25
Playing music from a Bluetooth device	26



AirPlay function	27
Playing songs from your iPhone, iPod touch, iPad or Mac	28
Playing songs from Windows PC	28
Play a song from your iPhone, iPod touch, iPad or Mac on multiple synced devices (AirPlay 2)	29
Spotify Connect function	30
Playing Spotify music with your speaker	30
Quick Select function	31
Operating this unit by voice with the Siri function	32
Stereo pairing	34

Troubleshooting

Troubleshooting	37
Cannot connect the speaker to the network	38
Cannot pair a Bluetooth mobile device with the speaker	38
Cannot hear Bluetooth music	38
Music cuts out or delays sometimes	39
I hear a delay when using the AUX input with my TV	39
Connecting to a network using an iOS device	40
I hear distortion when using the AUX input	40
Resetting network settings	41
Resetting your speaker	41
Buttons do not operate correctly	41
Cleaning of the fabric around the speaker	41

Status LED

Status LED table	42
-------------------------	-----------

Appendix

Power management	45
Enable/disable Wi-Fi and Bluetooth functions	46
Supported file types and codecs	47
Trademark information	48
Specifications	50



Thank you for purchasing this Denon product.

To ensure proper operation, please read this owner's manual carefully before using the product.

After reading this manual, be sure to keep it for future reference.

Accessories

Check that the following parts are included with the product.



Quick Start Guide



Safety Instructions



Power cord
(for Europe model)



Power cord
(for UK model)



Part names and functions

Front panel

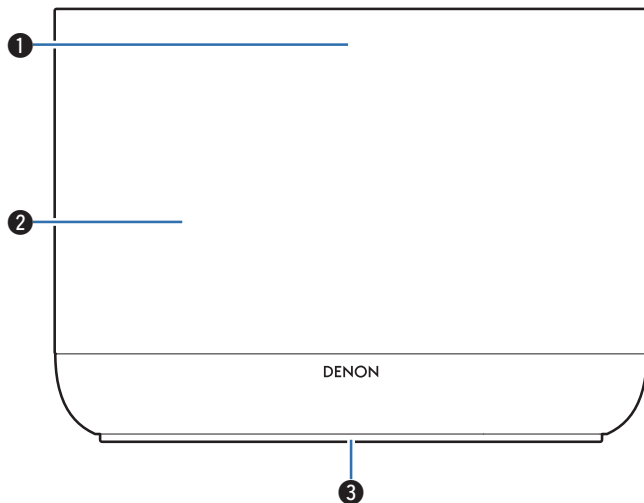

① Mic mute LED

While the microphone is disabled, the LED lights up in red.

② Speakers

③ Status LED

- Please refer to the “Status LED table” for LED color and state meaning. (👉 p. 42)
- While Siri responds, the LED lights up.



Side panel

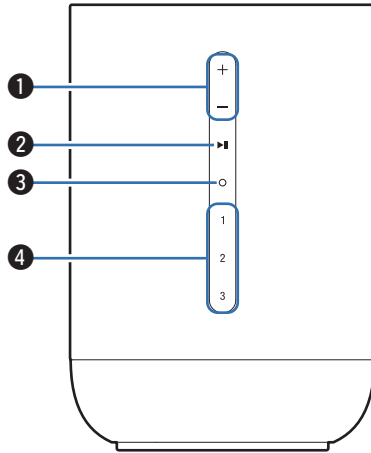

① Volume buttons (+, -)

These adjust the volume level.

② Play/Pause button (▶||)

- Press this button to pause during playback. If pressed while paused or stopped, resumes playback from the last track played.
- Press and hold the button for 5 seconds to enter Deep Standby mode. (📖 p. 45)
- Press this button twice during playback to play the next track.
- Press this button three times during playback to restart the current track or play the previous track.

③ Action button (○)

This calls Siri. You can use voice control without saying “Hey, Siri”. (📖 p. 32)

④ Quick select buttons (1 - 3)

Register input source settings to these buttons or recall those settings. (📖 p. 31)



Rear panel

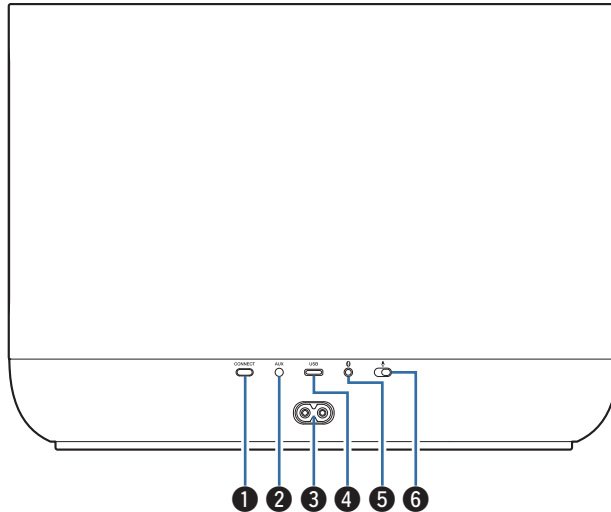

1 CONNECT button

Used for Wi-Fi setup. (🔗 p. 16)

2 AUX input connector (AUX)

Used to connect audio devices. (🔗 p. 25)

3 AC inlet

Used to connect the power cord. (🔗 p. 12)

4 USB-C® port

- Used to connect USB-C storage devices (such as USB flash drives). (🔗 p. 25)
- Used to connect this unit to a wired Ethernet network via a USB-C to Ethernet adapter (not included/An adapter up to 1Gbps is recommended). (🔗 p. 15)



- USB Type-C® and USB-C® are registered trademarks of USB Implementers Forum.

5 Bluetooth button (BT)

Used in the Bluetooth pairing settings. (🔗 p. 26)

6 Microphone mute switch (MIC)

Used to enable or disable the microphone function. In the state with the microphone function disabled, Siri does not respond even if called. Use this in cases such as when you want to protect your privacy. (🔗 p. 32)



- While the microphone is disabled, the action button (○) is also disabled.



Placing

You can place your speaker anywhere you want to enjoy great sounding music. Please follow these simple guidelines when determining where to place your speaker...

- The speaker must be within range of your wireless network.
- Locate the speaker at least 30 cm from a television, computer, or other display device to avoid the possibility of interference.
- Place the speaker across the room from where you will be listening, as close to ear level as possible.
- The speaker is not waterproof. Do not place it near any water source and do not leave it outside in the rain or snow.

NOTE

- Depending on the material and environment of the location where the speaker is placed, its rubber feet may discolor or have color transfer from the material.



Wall or floor stand mounting

The speaker has a screw hole on the bottom and can be mounted on a wall or floor stand using a standard speaker or camera mount/attachment (6.35 mm diameter, 10 mm length) that supports at least 16.8 kg. For more information, contact the store you purchased the speaker.

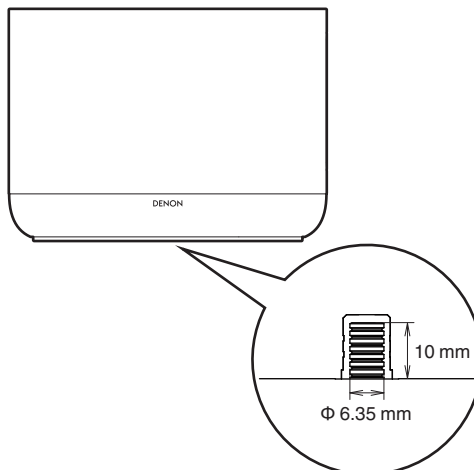

【Screw hole size】



Caution!

- Use a commercial bracket (not included) to attach this unit to the wall. Do not attach it directly to the wall.
- If attaching this unit to the wall or floor stand, check that it is attached securely. Please be aware that Denon accepts no responsibility for any damage if the unit falls.
- When using a commercial bracket (not included) to attach this unit to the wall, please ensure there is no gap between the base of the unit and the bracket.

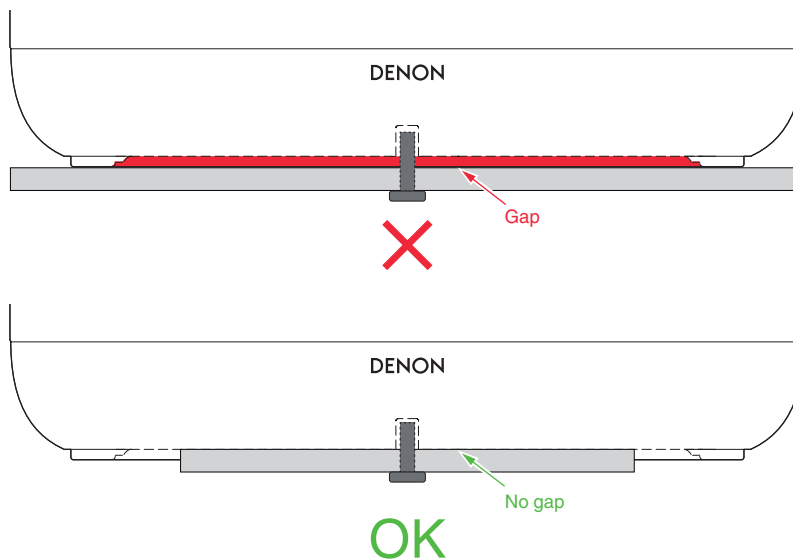

- Attach the speaker such that the front does not face downwards.

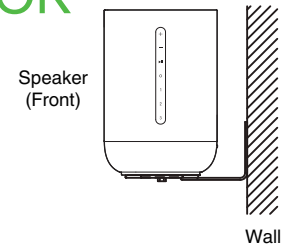
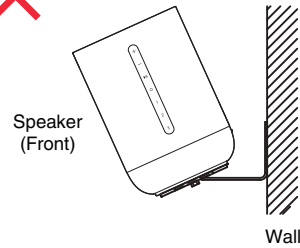
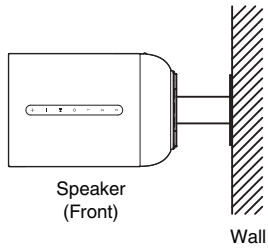

Powering your speaker

Connect the power cord included in the box to the rear panel of the speaker and the plug to a wall outlet. The speaker is capable of automatically switching between 100 - 240 V.

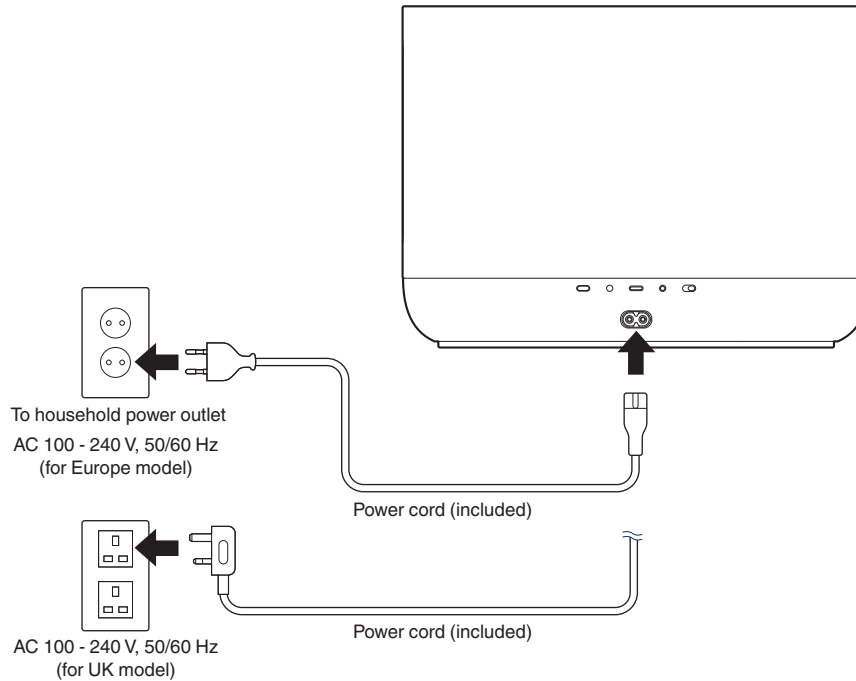

Getting the HEOS app

You can use many online music streaming services from the HEOS app. Depending upon your geographical location, there are several options to choose from.

Download the HEOS app for iOS or Android by searching App Store®, Google Play™ store or Amazon App Store for “HEOS”.



- For the purpose of improvement, the specifications and design are subject to change without notice.



Setting up the HEOS app for the first time with a HEOS Built-in device

Once you have placed your speaker in your listening room and have downloaded the HEOS app, you are ready to configure your speaker for music playback. This involves following a few simple steps to get the speaker connected to your existing home network:



- Do not connect the Ethernet cable if you are connecting your speaker to a wireless network. If you are connecting the speaker to a wired network, use a USB-C to Ethernet adapter (not included/An adapter up to 1 Gbps is recommended) and an Ethernet cable (not included) to connect the speaker to your network or router.

1 Make sure your mobile device is connected to your wireless network (the same network you want your speakers connected to).

You can check this in the “Settings” - “Wi-Fi” menu of your iOS or Android device.



- Activate the Bluetooth setting on your mobile device.
- If your wireless network is secure, make sure you know the password to join your network.

2 Launch the HEOS app on your mobile device.

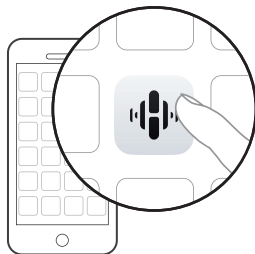

3 Tap the “Setup Now” button at the top of the screen.

4 Follow the instructions to add the speaker to your wireless network.



- If you have any problems connecting your speaker, jump to the Troubleshooting section ( p. 37).



Adding the registration of HEOS Built-in devices in the HEOS app

The HEOS system is a true multi-room audio system that automatically synchronizes audio playback between multiple HEOS Built-in devices so that the audio coming from different rooms is perfectly in sync and always sounds amazing! You can easily add up to 32 HEOS Built-in devices to your HEOS system.

Adding wired HEOS Built-in devices

Just connect the HEOS Built-in device to your home network using a USB-C to Ethernet adapter (not included/An adapter up to 1 Gbps is recommended) and an Ethernet cable (not included), and the HEOS Built-in device will appear on your HEOS app as a new room in the Rooms screen.

At your convenience, you can assign a name to the HEOS Built-in device to indicate which room you have it placed in.



- Use only a shielded STP or ScTP LAN cable which is easily available at electronics stores (CAT-5 or greater recommended).
- The normal shielded-type LAN cable is recommended. If a flat-type cable or unshielded-type cable is used, other devices could be affected by noise.
- Do not connect a NETWORK connector of the USB-C to Ethernet adapter connected to this unit directly to the LAN port/Ethernet connector of your computer.



Adding wireless HEOS Built-in devices

You can add additional wireless HEOS Built-in devices to your HEOS system by selecting “Add Device” from the HEOS app’s settings menu and follow the instructions:

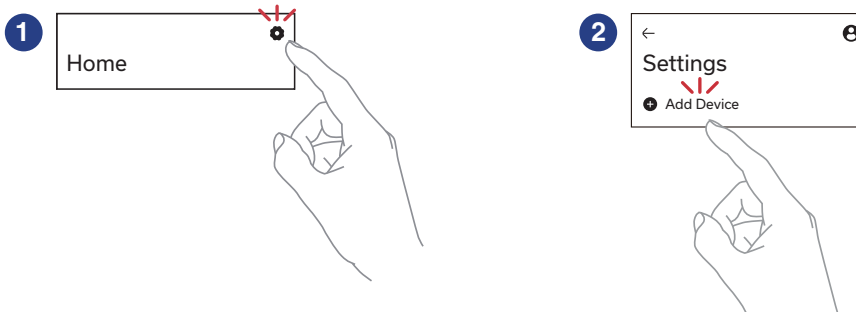

HEOS account

■ What is a HEOS account?

A HEOS account is master account or “keychain” for managing all of your music services with one single username and password.



■ Why do I need a HEOS account?

With a HEOS account, you only need to enter your music services login names and passwords once. This allows you to easily and quickly use multiple controller apps on different devices. You just log into your HEOS account on any device and you will have access to all of your associated music services, play history and custom playlists, even if you are at a friend’s house listening to music on their HEOS system.

■ Signing up for a HEOS account

You will be instructed to sign up for a HEOS account the first time you try to access any music service from the “Home” screen of the HEOS app.

■ Changing your HEOS account

- 1 Tap the “Home” tab.
- 2 Select the Settings icon  in the upper-right corner of the screen.
- 3 Select the HEOS Account icon .
- 4 Change your location, change your password, delete your account or sign out of your account.



Playing from streaming music services

A music service is an online music company that provides access to vast music collections via free and/or paid subscriptions. Depending upon your geographical location, there are several options to choose from.

NOTE

- The HEOS app and brand is not affiliated with any manufacturer of any mobile device. Availability of music services may vary by region. Not all services may be available at time of purchase. Some services may be added or discontinued from time to time based on decisions of the music service providers or others.

Selecting a room/device

- 1 Tap the “Rooms” tab. Select “Denon XXXXXXXX” if there are multiple HEOS built-in devices.



- Tap the 3 dots menu icon  at the top right to switch edit mode. You can change the displayed name.

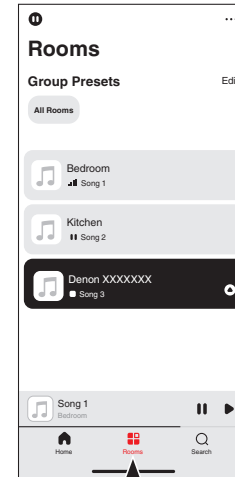

Selecting the music track or station from music sources

1 Tap the “Home” tab and select a music source.

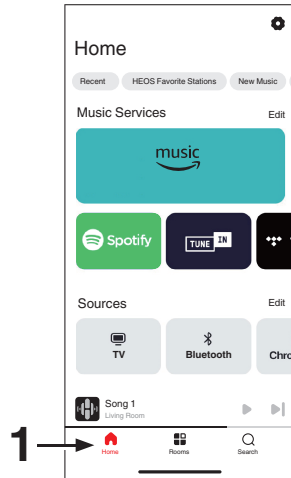

- All music services displayed may not be available in your location.

2 Browse the music to play.

After selecting a music track or radio station the app will automatically change to the “Now Playing” screen.

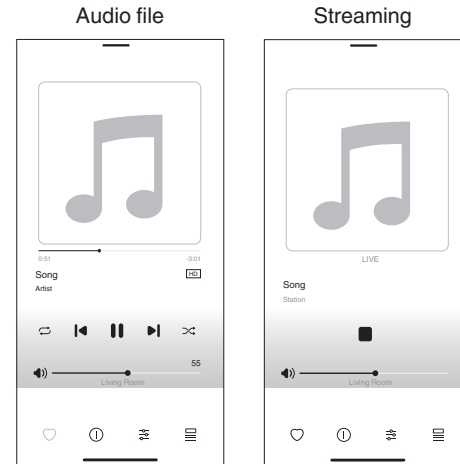

- The “Now Playing” banner appears on the “Home” screen, “Rooms” screen and “Search” screen. You can check the song currently playing and perform simple playback operations no matter which screen is displayed.



Listening to the same music in multiple rooms

This system is a true multi-room audio system. You can create one or more HEOS groups to automatically synchronize audio playback between multiple products with HEOS Built-in so that the music playing different rooms is perfectly in sync and always sounds amazing! You can easily add up to 32 products to your system in total. You can group up to 16 individual products to have them play the same song fully synchronized.

Grouping rooms

- 1 Press and hold your finger on room that is not playing music.**
- 2 Drag it into the room that is playing music and lift your finger.**

The two rooms will be grouped together into a single device group and both rooms will be playing the same music in perfect sync.



- You can also use the "Edit" function of the "Group Presets" to manage the group.

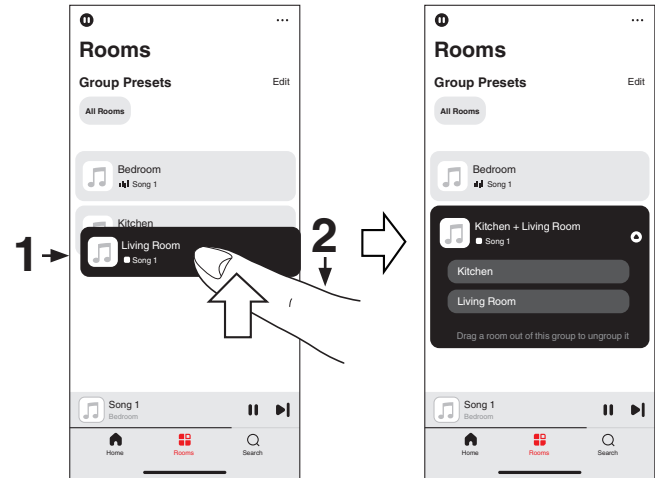

Ungrouping rooms

- 1 Press and hold your finger on room that you want to remove from the group.
- 2 Drag it out of the group and lift your finger.

NOTE

- You can not remove the first room that started playing the music before grouping.



- You can also use the “Edit” function of the “Group Presets” to manage the group.

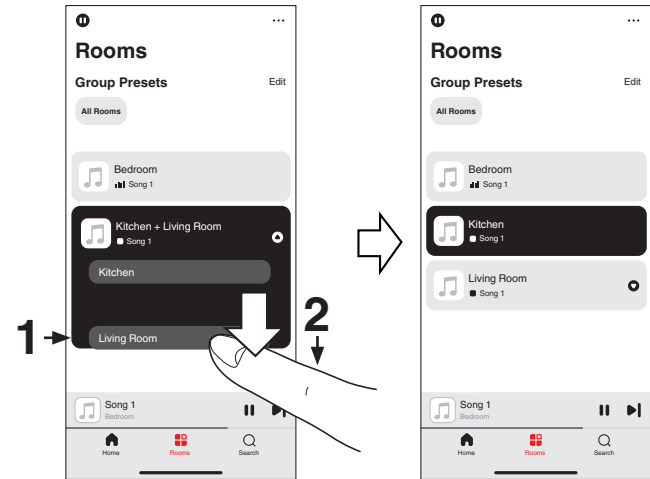

Grouping all rooms

You can easily group all rooms (up to 16 rooms) together by using a “pinch” gesture.

1 Place two fingers on the screen over the list of rooms.

2 Quickly pinch your two fingers together and release.

All of your rooms will be joined together and begin playing the same music in perfect sync.



- You can also use the “Edit” function of the “Group Presets” to manage the group.

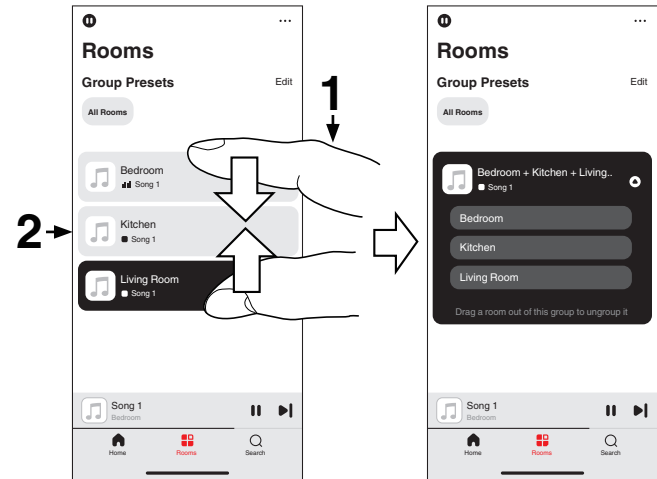

Ungrouping all rooms

You can easily ungroup all of your rooms by using a “spread” gesture.

- 1 Place two fingers close together on the screen over list of rooms.**
- 2 Quickly spread your two fingers apart from each other and release.**
All of your rooms will be ungrouped.



- You can also use the “Edit” function of the “Group Presets” to manage the group.

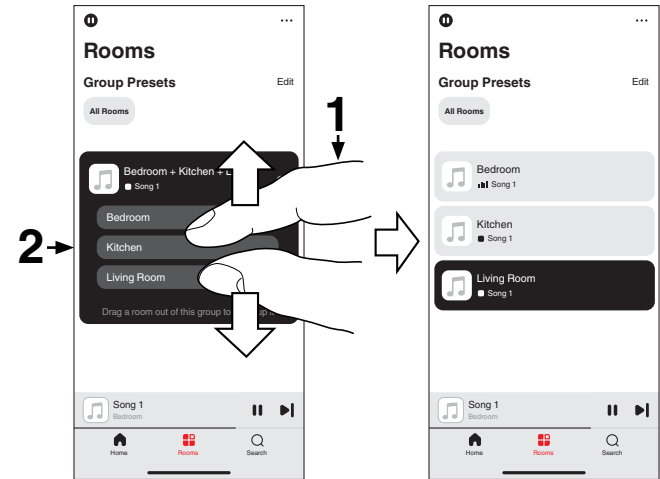

Listening to Internet Radio

The HEOS system includes access to more than 100,000 free internet radio streams from all corners of the globe via the TuneIn radio service. Just select the TuneIn logo from the “Home” screen and browse among the 100,000 stations neatly organized into popular categories and select a station that appeals to your mood.



- If you have a TuneIn account, tap “Edit” from the “Music Services” section of the “Home” screen, select “TuneIn” and sign in to the TuneIn service to access all “My Favorites” TuneIn stations.

NOTE

- The radio station database service may be suspended or be otherwise unavailable without notice.

Playing music stored on your mobile device

- 1** Tap the “Home” tab.
- 2** Select “This Phone” from the “Sources” section.
- 3** Browse the local music on your phone and select something to play.

Playing back files stored on a PC or NAS

- 1** Tap the “Home” tab.
- 2** Select “Server” from the “Sources” section.
- 3** Select the name of your networked PC or NAS (Network Attached Storage) server.
- 4** Browse the music on your PC/NAS and select something to play.



Playing music from the AUX input

1 Connect an audio device with a 3.5 mm stereo audio output to the AUX input on your speaker using a 3.5 mm stereo audio cable (not included).

When a 3.5 mm stereo audio cable is connected to “AUX IN”, the source automatically switches to Inputs.



- If a cable is connected to the AUX IN connector, select “Inputs” from the “Sources” section of the “Home” screen.

2 Initiate playback on the audio device.



- The sound from the audio device can be played directly on the selected speaker or digitized and sent over your network to other speakers.

NOTE

- The analog output signals from some sources can be fairly strong. If the input level of the source device is turned up high, it could overload the inputs of the speaker. This is unlikely to cause damage, but can cause distorted sound. Initially, set the volume of the source to a medium – low level, then turn it up as needed. If you hear distortion, turn down the device's volume control.

Playing music from a USB flash drive

- 1 Insert a FAT32 or NTFS formatted USB flash drive into the USB port on the rear panel of the speaker.
- 2 Tap the “Home” tab.
- 3 Select “USB” from the “Sources” section.
- 4 Select the name of your speaker.
- 5 Browse the music on your USB flash drive and select something to play.

NOTE

- It may take several minutes for the name of your speaker to appear in the “USB” list if you have a large number of files on your USB flash drive.
- It is not possible to connect and use a computer via the USB port of this unit using a USB cable.



Playing music from a Bluetooth device

1 Activate the Bluetooth setting on your mobile device.

2 Press the Bluetooth button (📶) located on the rear panel of the speaker.

When playing content via Bluetooth on the speaker for the first time, the speaker automatically enters pairing mode, and the status LED blinks blue twice.

- To pair with other Bluetooth devices, press and hold the Bluetooth button (📶) for 3 seconds until the status LED blinks blue twice.

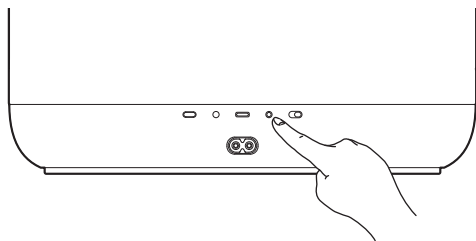

3 Select “Denon Home 400” from the list of available Bluetooth devices.

In a few seconds your mobile device will indicate that it is connected to your speaker.

4 Play music using any app on your device.

The sound will now play from the speaker.

NOTE

- If no sound is heard, disconnect and reconnect Bluetooth connections from your Bluetooth device.



AirPlay function

Music files stored on your iPhone, iPod touch, iPad, Mac or Windows PC can be played on this unit via the network.



- Input source will be switched to “AirPlay” when AirPlay playback is started.
- You can stop AirPlay playback by choosing another input source.
- The screen may differ depending on the OS and software versions.

This device supports AirPlay 2®.

Sync multiple AirPlay 2 compatible devices/speakers for simultaneous playback.



Playing songs from your iPhone, iPod touch, iPad or Mac

You can stream music stored in your “iPhone/iPod touch/iPad/Mac” directly to this unit.

- 1 Connect your iPhone, iPod touch, iPad or Mac Wi-Fi to the same network as this unit.**
 - For details, see your device’s manual.
- 2 Open Apple Music and play music from your iPhone, iPod touch, iPad or Mac.**
- 3 Tap or click the AirPlay icon and select this unit.**

[Example] iOS 15 or macOS 13



[Example] iOS 10



- You can also use AirPlay to stream music from other applications. Open the Control Center, tap or click the AirPlay icon, then select this unit.
- To use AirPlay, your iOS device must support iOS 10.0.2 or later, or OS X Mountain Lion 10.8 or later.

Playing songs from Windows PC

- 1 Install iTunes 10, or later, on a Windows PC that is connected to the same network as this unit.**
- 2 Start iTunes and click the AirPlay icon to select this unit.**

[Example] iTunes



- 3 Choose a song and click play in iTunes.**
The music will stream to this unit.



- For information about how to use iTunes, also see the Help for iTunes.



Play a song from your iPhone, iPod touch, iPad or Mac on multiple synced devices (AirPlay 2)

Songs from an iPhone, iPod touch, iPad or Mac can be synced with multiple AirPlay 2 supported devices for simultaneous playback.

1 Play the song on your iPhone, iPod touch, iPad or Mac.

AirPlay icon is displayed on the iPhone, iPod touch, iPad or Mac screen.

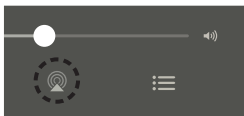

2 Tap or click the AirPlay icon and select this unit.

Displays a list of devices/speakers that can be played back on the same network.

- A circle is displayed to the right of AirPlay 2 compatible devices.

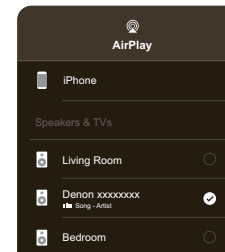

3 Select the devices/speakers you want to use.

- Multiple AirPlay 2 compatible devices can be selected.

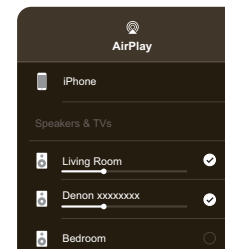

- To use AirPlay 2, your iOS device must support iOS 11.4 or later, or macOS Catalina or later.



Spotify Connect function

Spotify is all the music you'll ever need. Millions of songs available instantly. Just search for the music you love, or let Spotify play you something great. Spotify works on your phone, tablet, computer and home speakers. So you'll always have the perfect soundtrack for whatever you're doing. Now you can enjoy Spotify with your free account as well as a Premium account.

Use your phone, tablet or computer as a remote control for Spotify. Go to www.spotify.com/connect to learn how.

The Spotify software is subject to third party licenses found here: www.spotify.com/connect/third-party-licenses

Playing Spotify music with your speaker

Download the "Spotify App" onto your iOS or Android device beforehand.

- 1 Connect the Wi-Fi settings of the iOS or Android device in the same network as this unit.**
- 2 Launch the Spotify App.**
- 3 Play back a Spotify track.**
- 4 Tap the Spotify icon  to select the unit.**
The music will stream to this unit.



Quick Select function

Playback source settings can be registered to the Quick Select buttons (1 - 3).

- 1 To register the current settings, press and hold down one of the Quick Select buttons (1 - 3) on the side panel for 3 seconds.**



- The status LED blinks once when registration is complete.
- To recall the registered settings, press the Quick Select button on the side panel.
- The following settings can be registered to the Quick Select buttons. Register them in advance using the HEOS app.
 - Playback source/Sound Mode/Width/Height/Bass/Treble



Operating this unit by voice with the Siri function

This unit supports Siri, you can enjoy the ability to operate the unit and play music simply by speaking.

To use Siri, an Apple HomePod or Apple HomePod Mini must be connected to the same network as this unit.

Download the HEOS app in advance to your iOS device and then connect this unit to the network. (📖 p. 13)



Then enable Siri by setting the following in the HEOS app.

1 Enable Siri on Denon Home.

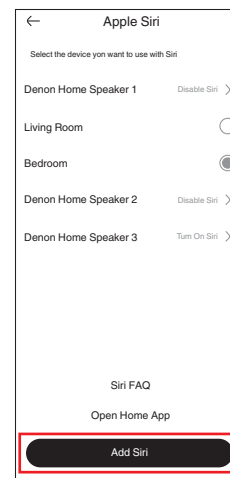
- Perform set up through the HEOS app.
Go to: “Home” - “Settings” - “Voice Assistants” - “Apple Siri”
Select the Denon Home speaker you wish to add and tap “Add Siri”.





- Instead of saying “Hey, Siri”, you can also press the  button on this unit to initiate voice control using Siri.
- In order to prevent Siri from responding by mistake or to protect your privacy, slide the  switch on this unit to display in red. The microphone mute LED on the front of the unit will be red and the microphone is disabled. The  button of this unit will also be disabled.

■ Examples of voice operation

For example, ask Siri the following:

- Asking Siri a question: “How’s the weather today?”
- Playing music: “Play the song xx”
- Operating this unit: “Increase the volume”





Stereo pairing

■ Creating a Stereo Pair

A matching pair of speakers that have been grouped together can be saved as a persistent Stereo Pair where one speaker outputs the left channel of audio and the other speaker outputs the right channel of audio. Paired speakers will then appear as a single room (with two speakers playing music) in the Rooms list.

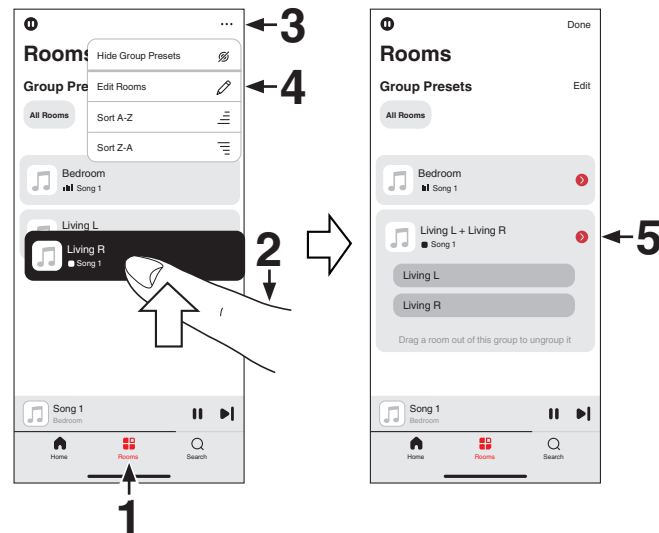
- 1** Tap the “Rooms” tab.
- 2** Create a group containing only two matching speakers (see “Grouping rooms” (p. 20)).
- 3** Tap the 3 dots menu icon .
- 4** Tap “Edit Rooms” to enter edit mode.
- 5** Tap on the group of two matching speakers to edit the group.



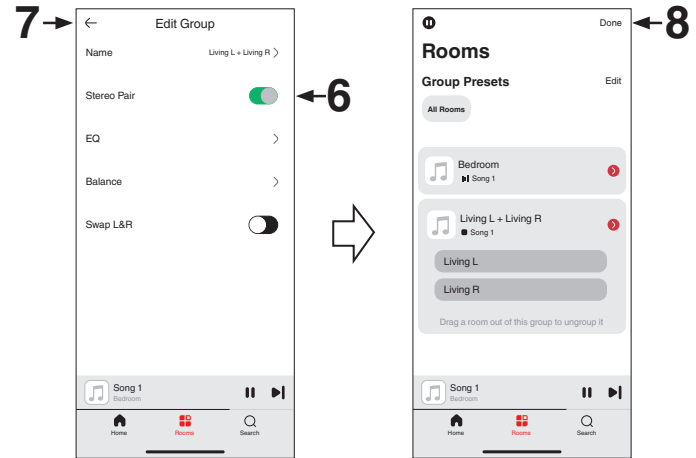

- 6** Tap on the “Stereo Pair” switch to pair the two speakers.
- 7** Tap the Back arrow  to return to the list of Rooms.
- 8** Tap “Done” to exit edit mode.

The group of two matching speakers will now appear as a single room. You can change the name of the stereo paired room at any time.



■ Removing a stereo pair

- 1 Tap the “Rooms” tab.
- 2 Tap the 3 dots menu icon .
- 3 Tap “Edit Rooms” to enter edit mode.
- 4 Tap a room which contains two matching speakers to edit the group.
- 5 Tap on the “Stereo Pair” switch to return the paired speakers to two individual speakers.
- 6 Tap the Back arrow  to return to the list of Rooms.
- 7 Tap “Done” to exit edit mode.



Troubleshooting

If a problem should arise, first check the following:

1. **Are the connections correct?**
2. **Is the set being operated as described in the owner's manual?**
3. **Are the other devices operating properly?**



- If steps 1 to 3 above do not improve the problem, restarting the device may improve the problem. Remove and re-insert the power cord of the unit.

If this unit does not operate properly, check the corresponding symptoms in this section.

If the symptoms do not match any of those described here, consult your dealer as it could be due to a fault in this unit. In this case, disconnect the power immediately and contact the store where you purchased this unit.



Cannot connect the speaker to the network

- Make sure your mobile device is connected to your wireless network before setting up your speaker. (👉 p. 14)
- Alternatively, you can connect your speaker to your network router using a USB-C to Ethernet adapter (not included/An adapter up to 1 Gbps is recommended) and an Ethernet cable (not included). Once connected via Ethernet, the HEOS app should recognize the speaker and you can manually move it to your wireless network using “Settings” - “My Devices” - (“Device Name”) - “Advanced” - “NETWORK SETTINGS”. (👉 p. 15)

Cannot pair a Bluetooth mobile device with the speaker

- The connection from the Bluetooth mobile device is malfunctioning. Power cycle the mobile device, remove the pairing information and re-pair the speaker to the mobile device.

Cannot hear Bluetooth music

- Your Bluetooth mobile device is not paired with the speaker. Re-pair the speaker to the mobile device.
- The speaker is Wi-Fi mode or Aux-in mode etc. Pair and connect Bluetooth device to the speaker.
- The Bluetooth mobile device is connected to another audio device. Make sure your Bluetooth device is connected to the speaker.
- The volume on the Bluetooth mobile device is too low. Check the volume on the Bluetooth mobile device. Check the volume on the speaker.



Music cuts out or delays sometimes

- Make sure your Internet connection is operating correctly. If you are sharing your network with other users or devices, they may be using most of your bandwidth (especially if they are streaming video).
- Make sure your speakers are within range of your wireless network.
- Make sure your speakers are not located near other electronic devices that could interfere with their wireless connectivity (like microwave ovens, cordless phones, TVs, etc.).

I hear a delay when using the AUX input with my TV

- If you are connecting the AUX input with your cable or satellite box for enjoying TV audio through multiple speakers, you may hear a delay between when you see someone speak and when you hear the audio. This is because the HEOS system must buffer the audio before it sends it out to the speakers so that it arrives at all speakers at the same time. (👉 p. 25)
- You can avoid this delay by listening only to the speaker which is directly connected to the set top box.



Connecting to a network using an iOS device

- This speaker supports Apple's WAC (Wireless Accessory Configuration) setup mode. WAC setup mode allows you to connect your speaker to your network without requiring you to type in the network name and password. The iOS device firmware version needs to support iOS 10.0.2 or later.
 1. Press and hold **-** and **▶||** buttons for 3 seconds.
 2. On your iOS device, go to the Wi-Fi menu under Settings.
 3. Select "Denon Home 400" under "SET UP NEW DEVICE..." at the bottom of the list.
 4. Follow the instructions on the screen to complete setup.

HEOS system will stay in WAC setup mode for 15 minutes. If the device is not setup within 15 minutes, it will revert back to its previous network connection. Press the **▶||** button if you want to cancel WAC setup mode.

NOTE

- During setup, you will be prompted to either scan the Apple HomeKit QR code or enter the setting code (8-digit number) that are affixed to the speaker or the included Quick Start Guide. However, if the network module is replaced at a service center, these codes will become invalid. You can use the HEOS app to connect this speaker to the network. (🔧 p. 14)

I hear distortion when using the AUX input

- The analog output signals from some sources can be fairly strong. If the input level of the source device is turned up high, it could overload the inputs of the speaker. This is unlikely to cause damage, but can cause distorted sound. Initially, set the volume of the source to a medium – low level, then turn it up as needed. If you hear distortion, turn down the device's volume control.



Resetting network settings

- If network content cannot be played or your speaker cannot connect to the network, resetting the network device (network router, etc.) may improve the problem. To reset the speaker's network settings, press and hold the CONNECT button located on the rear panel of the speaker for 10 seconds until the front LED begins to flash amber. Network settings are reset to the factory default values. After restoring the factory default settings, reconfigure the settings appropriately for your network.

Resetting your speaker

- Resetting your speaker will clear out the wireless network info, EQ, sound mode, name, etc., but retain its current software. You will have to use "Settings" - "Add Device" to reconnect the speaker to your home network before it can be used.
To reset your speaker, press and hold the CONNECT and Bluetooth (📶) buttons located on the rear panel of the speaker for 5 seconds until the front LED begins to flash amber.

Buttons do not operate correctly

- Unplug the power cord before cleaning the side panel.





Cleaning of the fabric around the speaker

- Use a soft cloth soaked in warm water and squeezed firmly to wipe off any stain.









Status LED table





The LEDs on the front panel change to indicate the current speaker status.

Speaker status	LED action	Description
Deep Standby mode	 (off)	Power is off, or the speaker is in Deep Standby mode. (👉 p. 45)
Network Standby mode	 (dimmed solid)	Speaker is in Network Standby mode. (👉 p. 45)
Power on	 (blink)	Speaker is starting up or connecting to the network.
	 (solid)	Speaker is connected to the network.
	 (solid)	Speaker is unable to connect to the network. Try to connect the speaker again.



Speaker status	LED action	Description
Bluetooth	 (two blinks)	Speaker is pairing via Bluetooth.
	 (solid)	Speaker is paired via Bluetooth (Connected to your network).
	 (one blink)	Speaker is paired via Bluetooth (Not connected to your network).
	 (for 3 sec. solid)	Speaker failed to pair to the Bluetooth device. Try to pair again. (👉 p. 26)
Volume setting	 (quick blink)	Volume is being adjusted.
	 (slow blink)	Speaker is muted.



Speaker status	LED action	Description
Firmware update	 (blink)	Firmware is being updated.
	 (slow blink (Not fade))	There is a firmware error. Check your usage environment, relaunch the app, then try to update the firmware again.
Error	 (solid)	There was a setup error. Check your usage environment, then follow the correct procedure to try setup again. If the error occurs again, reset and try setup again. (👉 p. 41)
	 (fast blink)	There is a hardware error. Unplug the power cord, wait a little while, then plug the power cord back in.
Reset	 (blink)	Factory settings have been restored.



Power management

■ Network Standby mode

This speaker automatically enters “Network Standby mode” to save power in the following cases. During “Network Standby mode”, speaker operations cause the power to turn on.

During “Network Standby mode”, the status LED lights in dim white.

❑ Ethernet

After 20 minutes of no operation and no network access after playing music via Ethernet.

❑ Wi-Fi

After 20 minutes of no operation and no network access after playing music via Wi-Fi.

❑ USB

After 20 minutes of no operation and no network access after playing music from a USB flash drive.

❑ Bluetooth

After the Bluetooth connection is disconnected and there is 20 minutes of no operation and no network access after playing music via Bluetooth.

❑ AUX IN

After 20 minutes of no audio.

■ Deep Standby mode

The device also has the ability to automatically enter “Deep Standby mode” whenever the wired or wireless network connection is removed for more than 60 minutes in “Network Standby mode”. The front panel LED will turn off during “Deep Standby mode”.

Press any button to turn the power on.



- You also press the ►|| button for 5 seconds, the device enters the “Deep Standby mode”.

NOTE

- If “Power Saving” is set to “Quick Start” in the HEOS app, the unit will not switch to Deep Standby mode. (“Settings” - “My Devices” - (“Device Name”) - “Power Saving”)

■ Off

To completely turn off the power to the device, you must remove the mains plug from the power outlet.



Enable/disable Wi-Fi and Bluetooth functions

By disabling Wi-Fi and Bluetooth functions, you can reduce power consumption in Network Standby mode. Select “Network” from the settings menu in the HEOS app to set it up. Follow these steps to set it up:

- 1** Tap the “Home” tab.
- 2** Select the Settings icon  in the upper-right corner of the screen.
- 3** Select “My Devices”.
- 4** Select “Denon Home 400”.
- 5** Select “Network”.

■ Wi-Fi

On (Default):	Wi-Fi function enabled.
-------------------------	-------------------------

Off:	Wi-Fi function disabled.
-------------	--------------------------



- When setting Wi-Fi to “Off”, use a USB-C to Ethernet adapter (not included/An adapter up to 1 Gbps is recommended) and an Ethernet cable (not included) to establish the network connection.

■ Bluetooth

On (Default):	Bluetooth function enabled.
-------------------------	-----------------------------

Off:	Bluetooth function disabled.
-------------	------------------------------



Supported file types and codecs

Codec	Sampling frequency	Bit rates	Bit length	File extension
PCM	32/44.1/48/88.2/ 96/176.4/192 kHz	---	16/24 bit	wav
MPEG-1 Audio Layer 3 CBR/VBR	32/44.1/48 kHz	32 - 320 kbps	16 bit	mp3
AAC-LC	32/44.1/48 kHz	48 - 320 kbps	16 bit	m4a aac
wma9 CBR	32/44.1/48 kHz	CBR:48 - 192 kbps	16 bit	wma
flac	44.1/48/88.2/ 96/176.4/192 kHz	---	16/24 bit	flac
ALAC	44.1/48/88.2/ 96/176.4/192 kHz	---	16/24 bit	m4a
DSDIFF DSF	2.8/5.6 MHz	---	1 bit	dff dsf

NOTE

- Files protected by DRM, such as Apple's FairPlay DRM, are not supported.
- If you select a music source with a high bit rate or high resolution, it is set to the appropriate level by codec before being output.
- The ALAC decoder is distributed under the Apache License, Version 2.0 (<http://www.apache.org/licenses/LICENSE-2.0>)



Trademark information



Google Play and the Google Play logo are trademarks of Google LLC.



App Store® is registered in the U.S. and other countries.



Dolby, Dolby Atmos, and the double-D symbol are registered trademarks of Dolby Laboratories Licensing Corporation. Manufactured under license from Dolby Laboratories. Confidential unpublished works. Copyright © 2012–2024 Dolby Laboratories. All rights reserved.



Wi-Fi CERTIFIED 6® and the Wi-Fi CERTIFIED 6 Logo are registered trademarks of Wi-Fi Alliance®. Wi-Fi Certification provides assurance that the device has passed the interoperability test conducted by the Wi-Fi Alliance, a group that certifies interoperability among wireless LAN devices.



The Bluetooth® word mark and logos are registered trademarks owned by the Bluetooth SIG, Inc. and any use of such marks by DEI Sales, Inc. is under license. Other trademarks and trade names are those of their respective owners.





Apple, AirPlay, iPad, iPad Air, iPad Pro, iPhone and Mac are trademarks of Apple Inc., registered in the U.S. and other countries.

iOS is a trademark or registered trademark of Cisco in the U.S. and other countries and is used under license.

The trademark "iPhone" is used in Japan with a license from Aiphone K.K.

Use of the Works with Apple AirPlay badge means that an accessory has been designed to work specifically with the technology identified in the badge and has been certified by the developer to meet Apple performance standards.



Apple, Apple Home, HomeKit, HomePod, HomePod mini, AirPlay, iPad, iPad Air, iPad Pro and iPhone are trademarks of Apple Inc., registered in the U.S. and other countries.

Use of the Works with Apple badge means that an accessory has been designed to work specifically with the technology identified in the badge and has been certified by the developer to meet Apple performance standards. Apple is not responsible for the operation of this device or its compliance with safety and regulatory standards.

ROON READY

Being Roon Ready means that Denon uses Roon streaming technology, for an incredible user interface, simple setup, rock-solid daily reliability, and the highest levels of audio performance, without compromise.



Specifications

Wireless LAN

Network type:	Conforming to IEEE 802.11 a/b/g/n/ac/ax
Used frequency range:	2.4 GHz, 5 GHz, 6 GHz

Bluetooth® Technology

Supported Audio Formats:	SBC
Supported Audio Applications:	Classic Audio (AVRCP) – RX only
Transmit Power:	Power Class 1
Typical Range:	30 m in line of sight *

* The actual communication range varies depending on the influence of such factors as obstructions between devices, electromagnetic waves from microwave ovens, static electricity, cordless phones, reception sensitivity, antenna performance, operating system, application software, etc.



General

Operating temperature:	5 °C - 35 °C
Power supply:	AC 100 – 240 V, 50/60 Hz
Power consumption:	25 W
Power consumption in Network Standby mode:	

Connection	Setting items in the HEOS app		Power consumption
	Wi-Fi (🔑 p. 46)	Bluetooth (🔑 p. 46)	
Wi-Fi 2.4 GHz	On	Off	1.8 W
Wi-Fi 5 GHz	On	Off	1.8 W
Wi-Fi 6 GHz	On	Off	1.8 W
Bluetooth	Off	On	1.5 W
USB Type-C to Ethernet adapter	Off	Off	2.0 W
All network ports enabled	On	On	2.3 W

Power consumption in Deep Standby mode:	0.3 W
Max analog input:	2 Vrms



Dimensions

Unit : mm

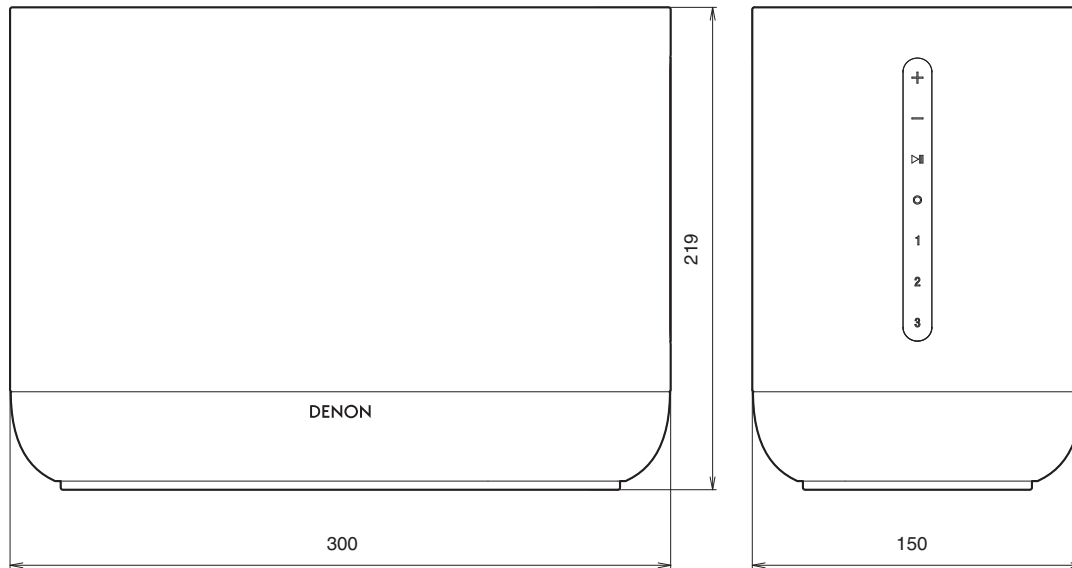

Weight : 4.2 kg

For the purpose of improvement, the specifications and design are subject to change without notice.



DENON®

www.denon.com

3520 11026 00ASA